

# Side Steps

## Mounting instructions for Toyota Land Cruiser 150 2018

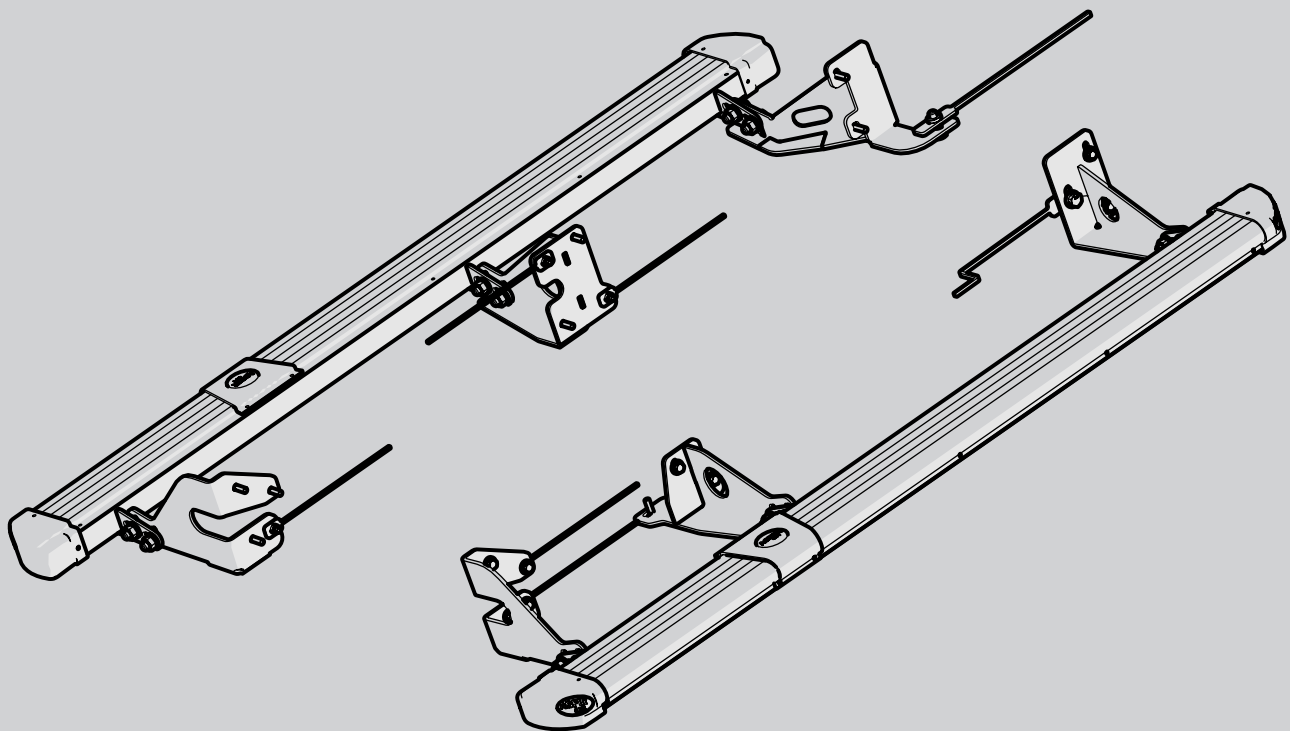

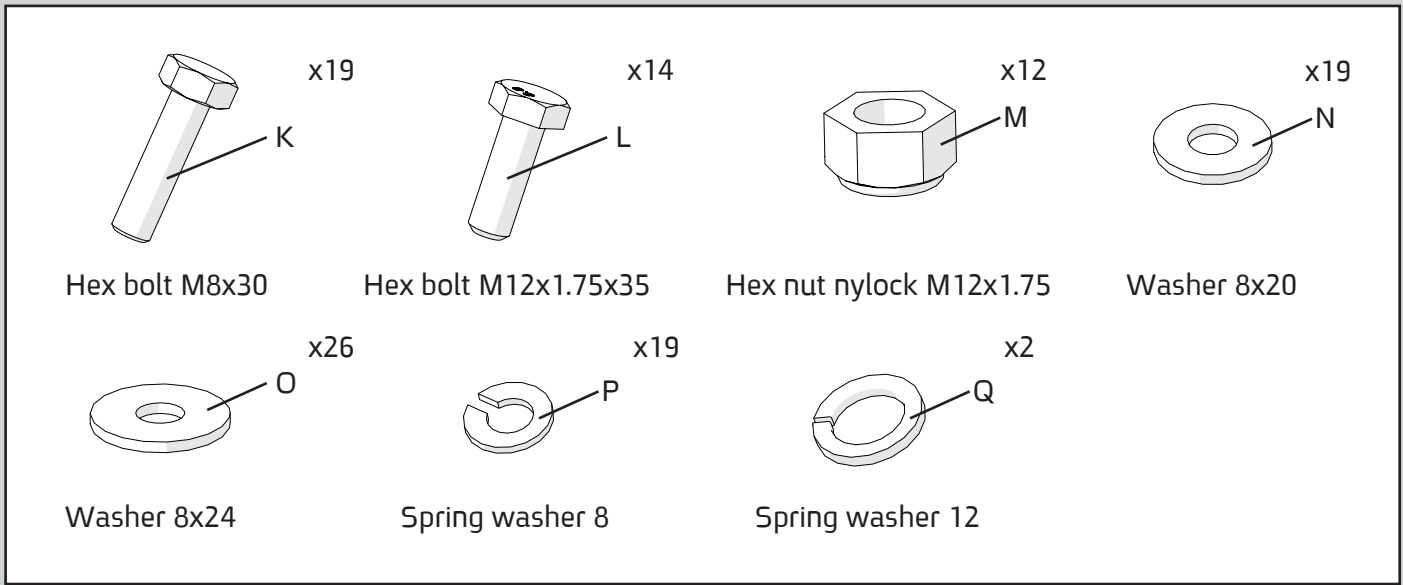
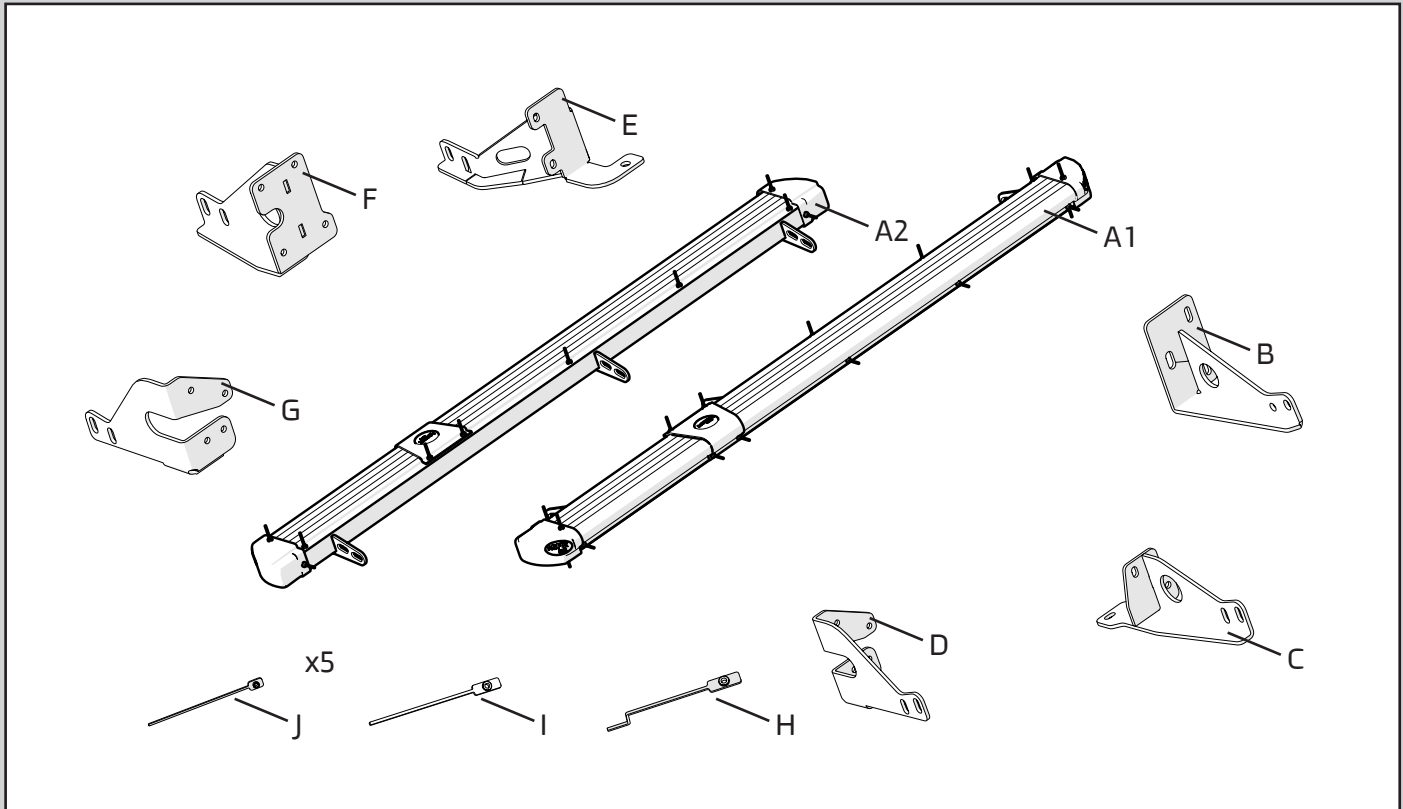

Maximum Tightening Torques	
M8 (8.8)	25 Nm
M10(8.8)	50 Nm
M12(8.8)	85 Nm

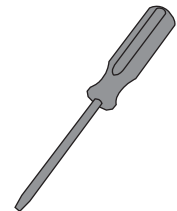
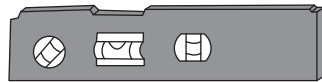
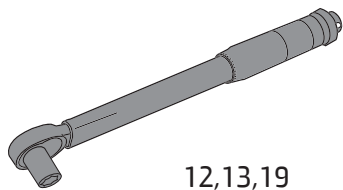

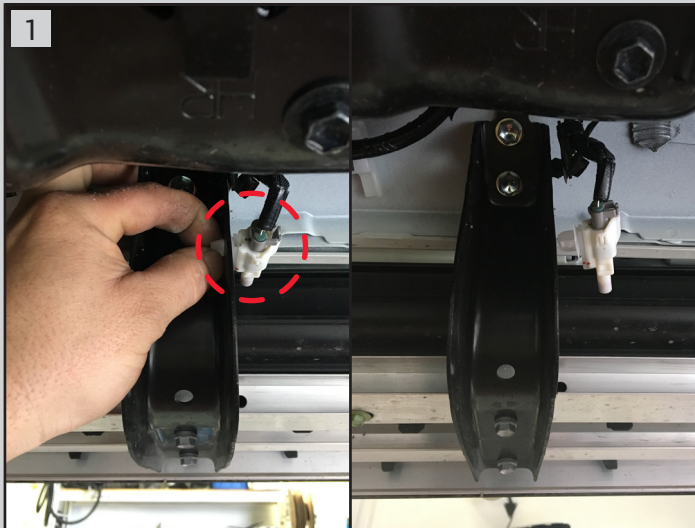

On the right step middle bracket release the electrical outlet and push it out side from the bracket



Insert the electrical outlet to the metal bracket as shown



Remove 6 bolts and dispose left step

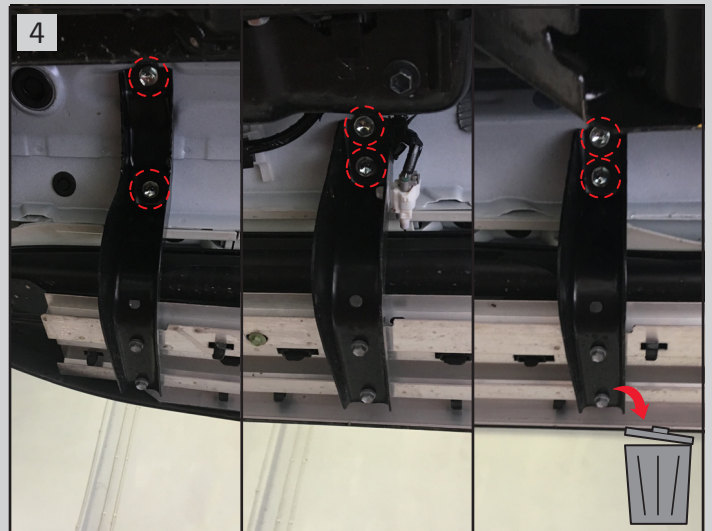
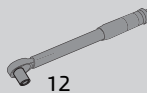

Remove 6 bolts and dispose the right step

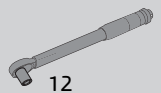

Right front bracket (B):  
On the chassis outer side remove the 2 caps



Place bracket (B) on chassis. Connect it to chassis using hex bolt (K), spring washer (P) and washer (N)





7  
Insert spacer nut (H) through the hole into the chassis and align it to the hole of bracket (B)



8  
Connect bracket (B) to the chassis using hex bolt (L), spring washer (Q) and washer (O) to the spacer nut.  
Tighten hex bolt (K), spring washer (P) and washer (N)

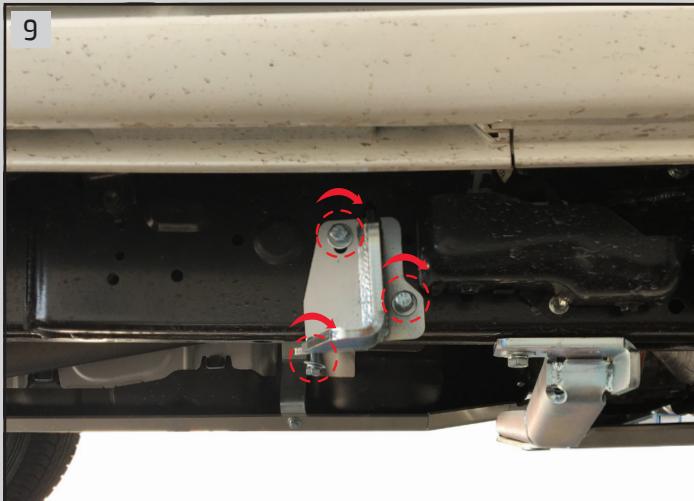
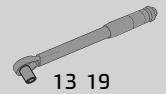

9  
Middle right bracket (C):  
Connect bracket (C) to chassis original screw using hex bolt (K), spring washer (P) and washer (N)

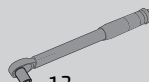

10  
Rear right bracket (D):  
Remove the cap



11  
Place bracket (D). Insert 2 plates (J) through the chassis

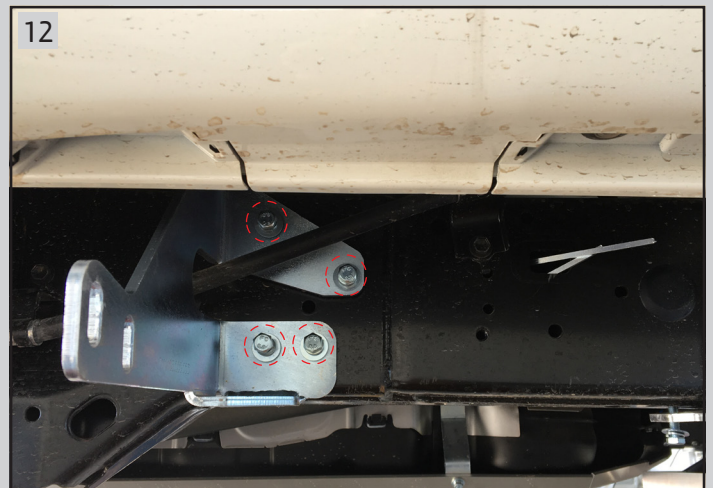

12  
Connect bracket (D) to chassis using hex bolt (K), spring washer (P) and washer (N).  
Left 2 hex bolts to original screwing and right 2 hex bolts to the plates (J)

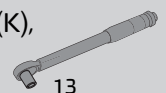



Tighten all 3 brackets bolts

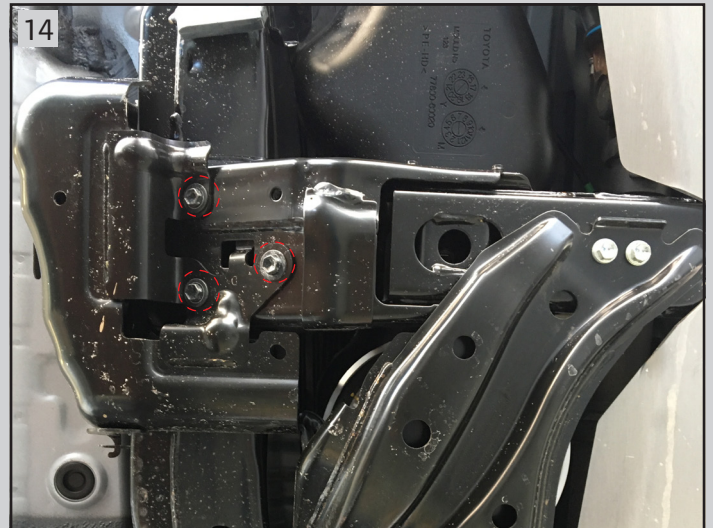

Front left bracket (E):  
Open 3 bolts and remove plate to connect  
the bracket

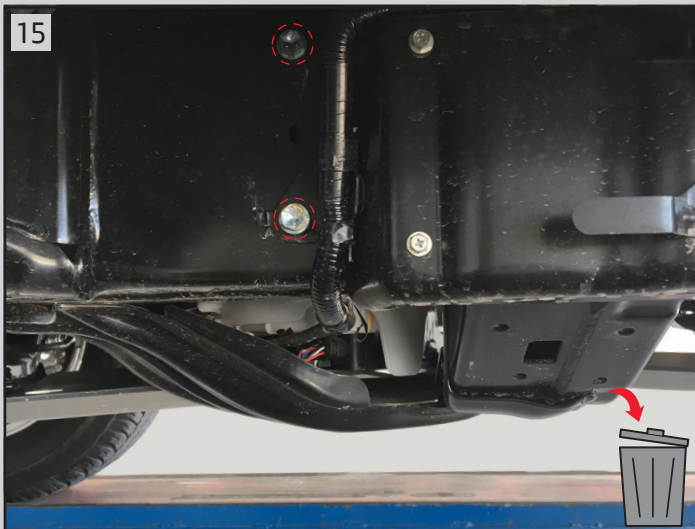
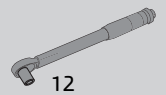

Open 2 bolts and dispose them

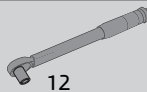

Remove cap

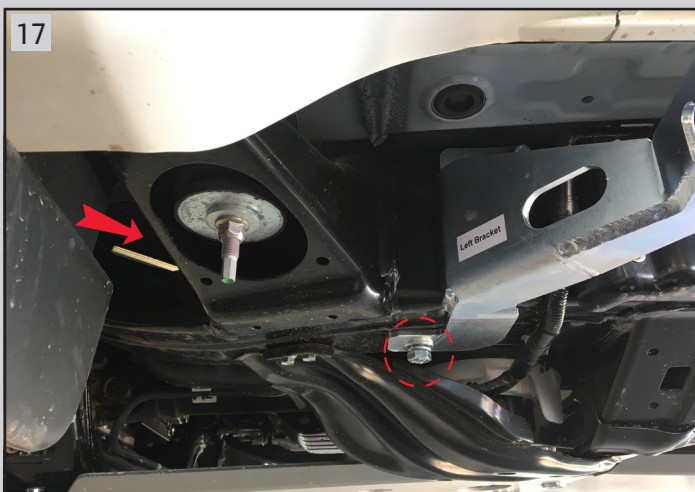
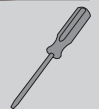

Insert spacer nut (I) through the chassis.  
Connect bracket (E) to chassis using hex  
bolt (L), spring washer (Q) and washer (O)  
through the spacer nut

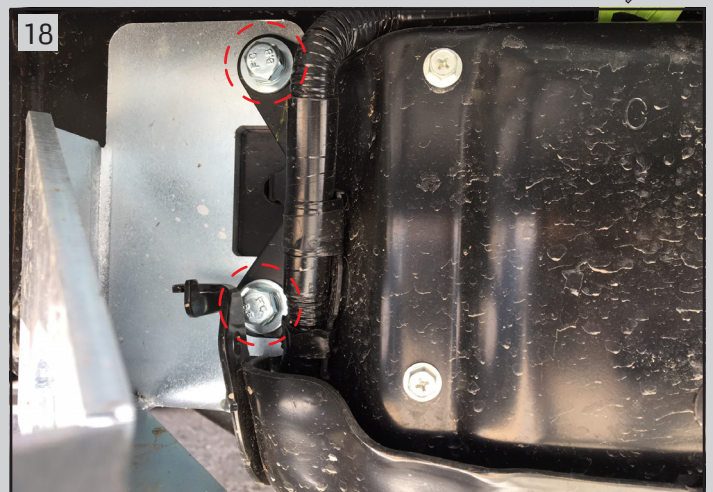
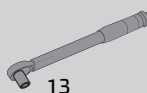

Connect bracket (E) to chassis original screwing  
using hex bolt (K), spring washer (P) and  
washer (N)

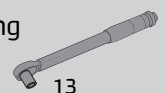

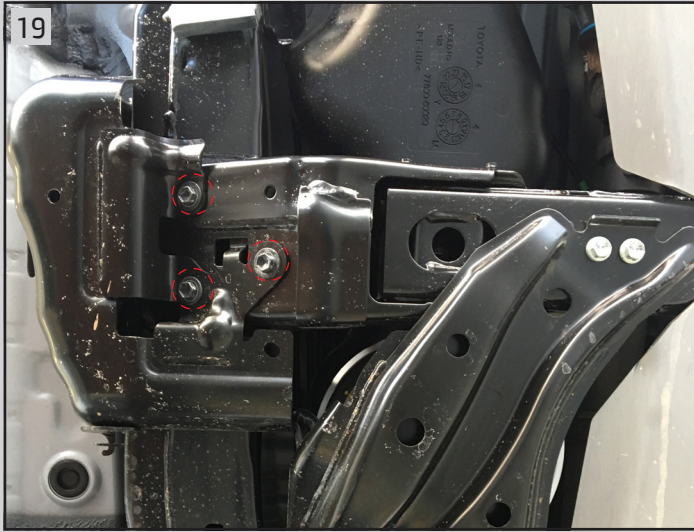

19 Place back the plate and tighten back the 3 bolts.

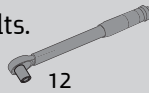

20 Middle left bracket (F):  
Remove 2 caps

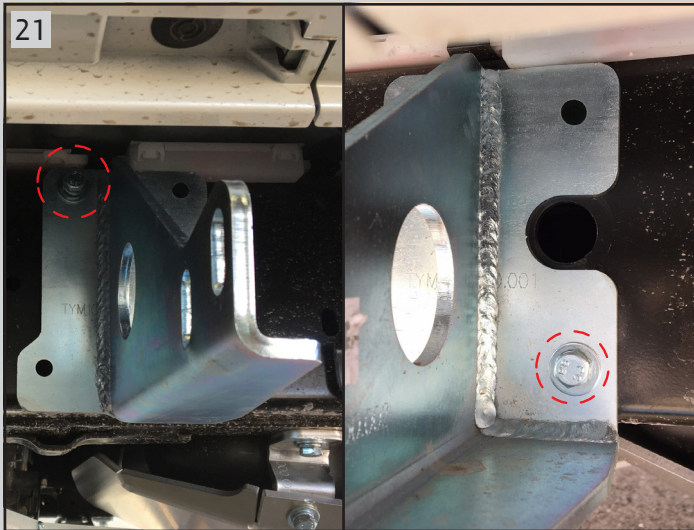

21 Connect bracket (E) to chassis through original screwing using hex bolt (K), spring washer (P) and washer (N)

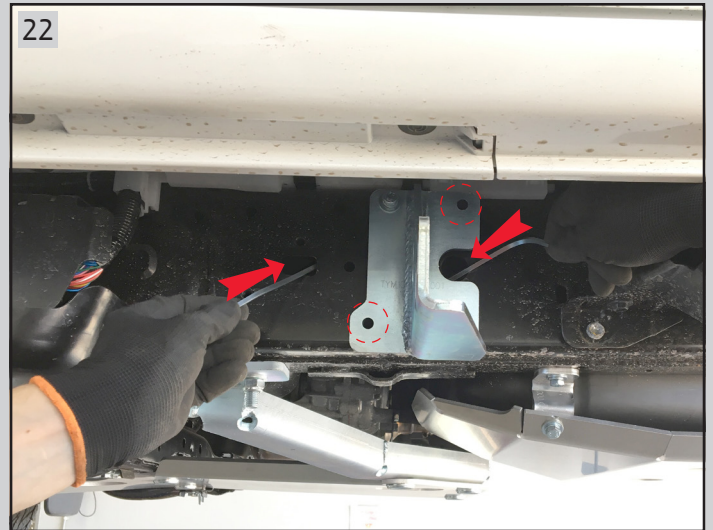
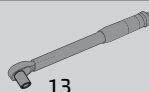

22 Insert 2 spacer nuts (J) on opposite directions and align it to the holes



23 Connect the bracket to the chassis using hex bolt (K), spring washer (P) and washer (N) to spacer nuts

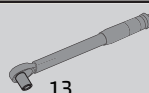

24 Rear left bracket (G):  
Remove cap

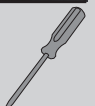

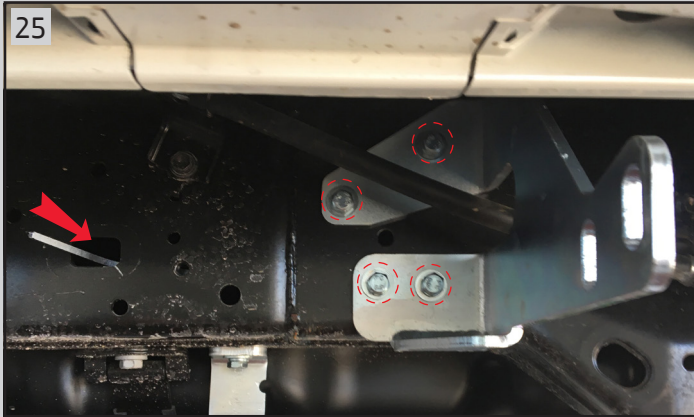

25  
Insert the spacer nut through chassis and align it to left lower hole. connect bracket (G) to chassis original screwing and spacer nut using hex bolts (K), spring washer (P) and washer (N). Tighten all brackets bolts

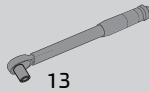

26  
Place the right and left steps (A1+A2) on the brackets. Make sure with a leveler that the steps are straight and parallel to the bottom line of the vehicle doors. Make sure the steps are horizontal in all dimensions



27  
Connect the steps to the brackets using hex bolt (L), washer (O-on both sides of brackets) and hex nut (M)

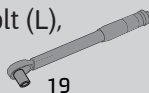

28  
Connect the steps to the brackets using hex bolt (L), washer (O-on both sides of brackets) and hex nut (M). Tighten all steps bolts

