

Fuel tank skid plate Mounting instructions for Toyota Hilux 2016-18

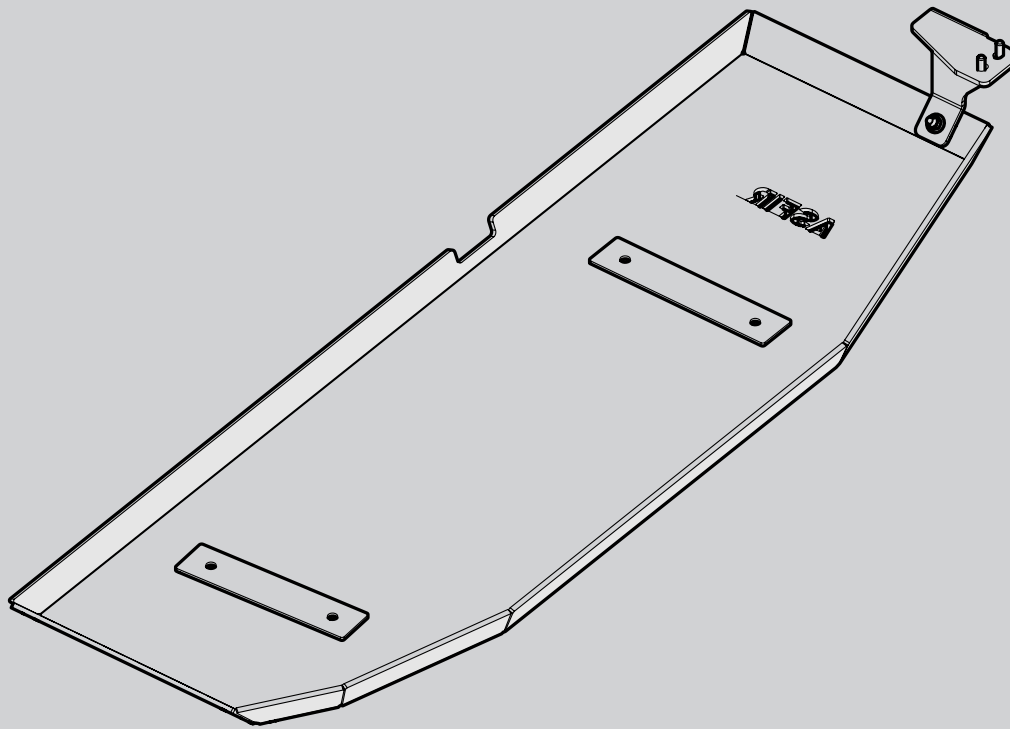

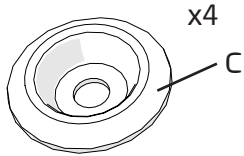

Pocket washer 8

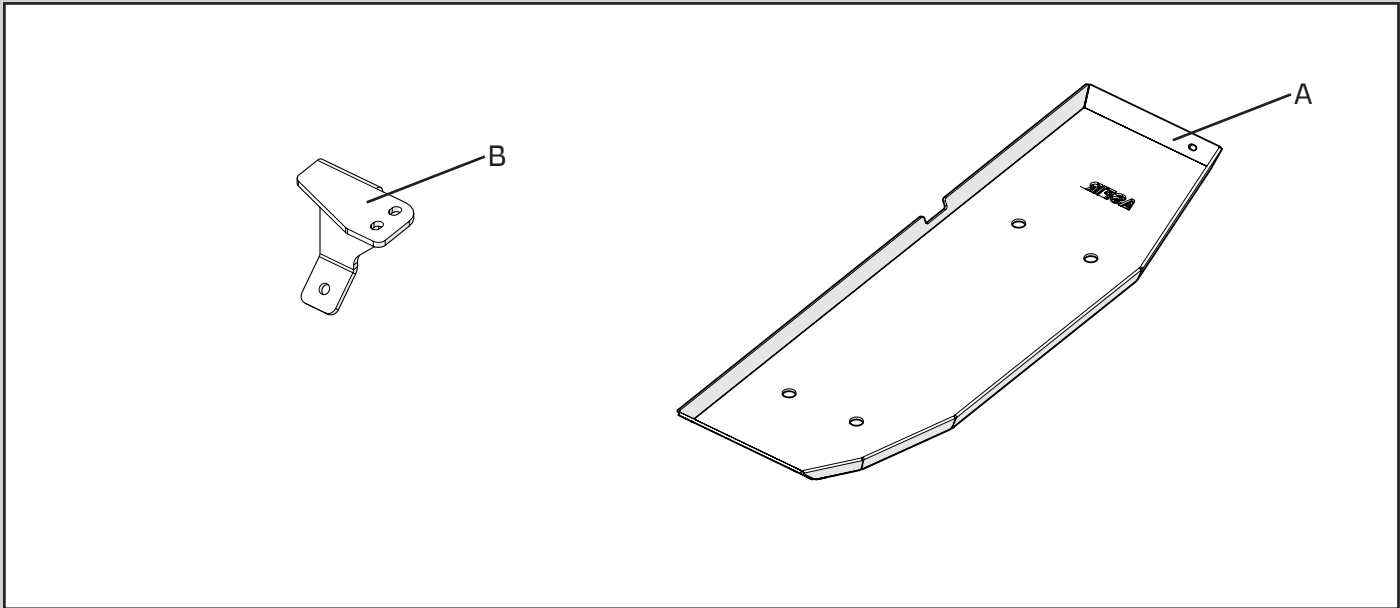
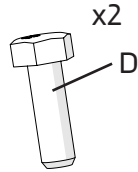

Hex bolt M8x25

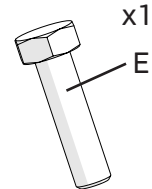

Hex bolt M8x30

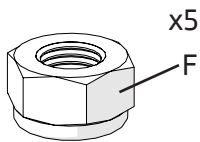

Hex nut nylock M8

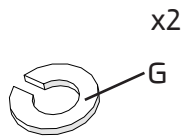

Spring washer 8

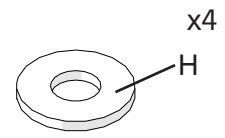

Washer 8x20

Maximum Tightening Torques

M8 (8.8)

25 Nm

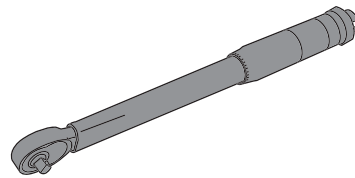

12,13

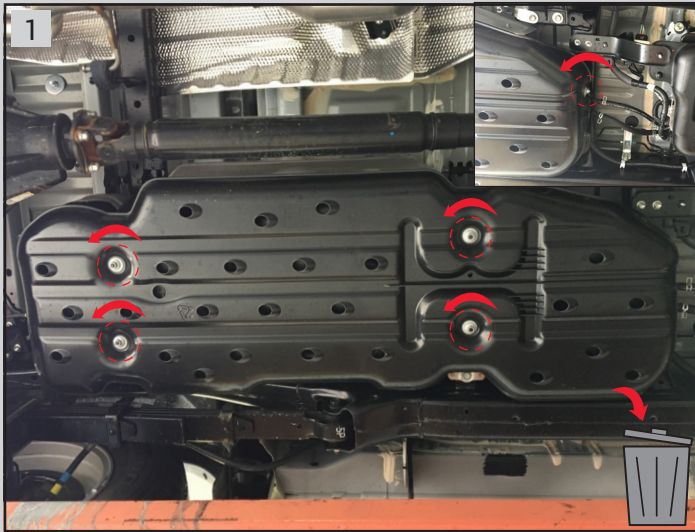

Open 5 bolts of the fuel tank plate and remove the plate. Save the bolts for later use. Dispose the plate

12



Remove 2 bolts of urea tank

12



Place bracket (B) and tighten 2 hex bolts (D), spring washer (G) and washer (H) through bracket (B) and chassis

12



Connect plate (A) using 4 original bolts with hex nut (F), pocket washer (C) to original screwing

13



Connect plate (A) to bracket (B) using bolt (E), washer (H- on both sides of the plate) and hex nut (F)