

CRAFTED LIKE NO OTHER

DON'T JUST SETTLE
FOR THE SAME
OLD BULL

OWNER MANUAL

ISUZU
D-MAX 2017+

AFN[®]
4 X 4 ACCESSORIES



WELCOME TO THE AFN FAMILY

This manual contains the **Isuzu D-MAX +2017** fitting instructions for:
Bull Bar Ref.: 48002395 **Front Bumper Ref.: 48002424**

1 INTRODUCTION



The Company

Founded in 1995, AFN - 4x4 Accessories dedicates itself to the production and commerce of all-terrain accessories. Its constant concern in its customers total satisfaction, and in the ideals of innovation and transformation have granted a position of notability both in the national and international panorama.

The only company in Portugal in the mass production of 4x4 accessories, relies on specialized and experienced technicians, with the most adequate knowledge, to an efficient response capability to its customers demands.

Thanks to the specialization in the several areas of design and manufacture and to a constant investment in technology, AFN has been broadening its wide range of products, without ever neglecting the quality factor.

4x4 Accessories

In its diversity of products we can include, with all-terrain quality, protection, safety and aesthetic accessories.

And it is here that AFN invest on the best technology, the best cut precision of the raw material, and the transformation of products with the quality recognized in the marketplace.

AFN has, at its disposal, resources to test and analyse the resistance of its products and stands in the front row regarding the European homologation of materials dedicated to all terrain.

The contact with the most important test laboratories for vehicles, both in England, Spain and Germany, provides AFN with the know-how to manufacture a wide range of quality products.

Our Design Approach

AFN designs each accessory taking into consideration the original model lines and fitting points. We refuse to have a "one design fits all" solution and we are always looking forward to embrace new challenges on how to adjust a new product into a new model!

The days of just throwing on a bit of steel together to form a protection system are gone. AFN is leading the way modern vehicle protection components are manufactured. Other will follow, and it won't be long where the AFN approach to Styling, Fit, Form and Function will become the benchmark for all other manufacturers.





INDEX

AFN 4x4 Accessories

Product: **Bull Bar**

Part Ref.: **48002395**

Product: **Front Bumper**

Part Ref.: **48002424**

Introduction 2

1 Checklist 4

Product 48002395

Product 48002424

2 Fitting Instructions 7

3 D-MAX Catalogue 15

4 Warranty Terms 16

5 AFN 4x4 Partners 17



1 CHECKLIST

- In this section you have a checklist with all parts included for the installation of your AFN product
- This product should be installed as demonstrated in the product fitting instructions
- If verified that any component is damaged, please contact your nearest AFN distributor
- The specified parts will only fit in the models specified by AFN
- Do not modify any component of the product

This checklist is for product **48002395** and **48002424**.

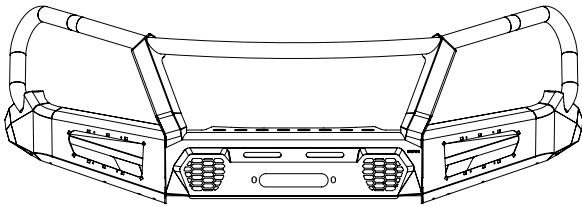

Ref.: 47001900

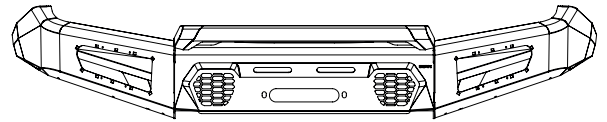

Ref.: 47001949



Ref.: 48002192

X1



Ref.: 48002191

X1



Ref.: 47001901

X1



Ref.: 47001602

X1



Ref.: 47001601

X1



Ref.: 46007413
Thickness: 2 mm

X1



Ref.: 46007412
Thickness: 4 mm

X1

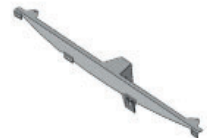

Ref.: 46007411

X1



Ref.: 46007401
Thickness: 1.5 mm

X6



Ref.: 46007366

X2



Ref.: 46007277

X1



Ref.: 46007276

X1



Ref.: 46007275 X1



Ref.: 46007274 X1



Ref.: 46007188 X1

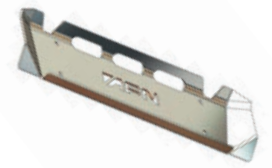

Ref.: 46007187 X1



Ref.: 46007186 X1



Ref.: 46007185 X1



Ref.: 46007184 X1



Ref.: 46007183 X1



Stainless Steel
Ref.: 46007001
M12x40x40 X12



Ref.: 46005518 X1



Ref.: 45001131 X1



Ref.: 45001127
Ø6 X12



Stainless Steel
Ref.: 45001123
M3,5x16 X16

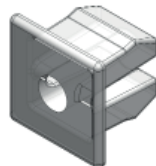

Ref.: 45001113 X16

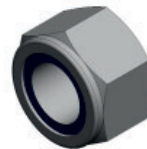

Stainless Steel
Ref.: 45001033
M12 X2



Stainless Steel
Ref.: 45001029
M12x40 X2



Ref.: 45001012
M6 X10



Stainless Steel
Ref.: 45001000
M4 X6

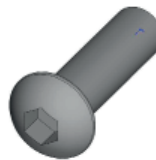

Stainless Steel
Ref.: 45000998
M6x20 X10



Stainless Steel
Ref.: 45000995
M12 X4

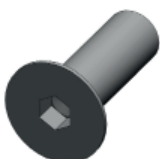

Stainless Steel
Ref.: 45000934
M10x30 X6



Stainless Steel
Ref.: 45000931
M6x15x1,6 X10



Stainless Steel
Ref.: 45000500
M6 X2

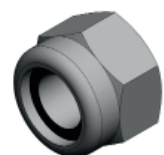

Stainless Steel
Ref.: 45000294
M6 X2



Zinc Plated
Ref.: 45000067
M12x35

X10

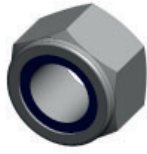

Zinc Plated
Ref.: 45000066
M12

X10



Zinc Plated
Ref.: 45000038
M10x80x30

X4



Zinc Plated
Ref.: 45000036
M12

X8



Zinc Plated
Ref.: 45000018
M8

X2

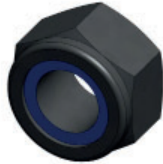

Zinc Plated
Ref.: 45000017
M10

X6



Zinc Plated
Ref.: 45000011
M8

X4



Zinc Plated
Ref.: 45000010
M10

X22



Zinc Plated
Ref.: 45000008
M8x30

X2

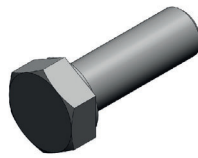

Zinc Plated
Ref.: 45000007
M10x30

X8

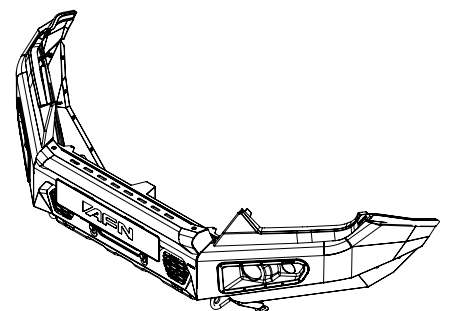
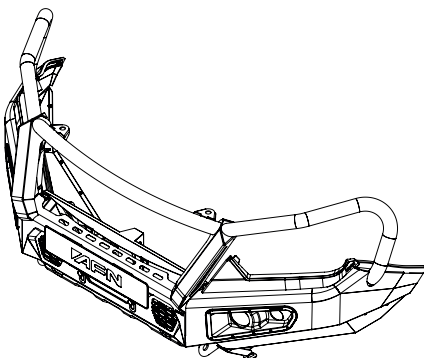



2 FITTING INSTRUCTIONS

WARNING:

Before you begin installation, read all instructions thoroughly.
Proper tools will improve the quality of installation and reduce the time required.

- This product should be installed as demonstrated in the *Product «Fitting Instructions»*;
- The specified parts, will only fit the models specified by **AFN**;
- Do not modify any component of the product;
- It is recommended that this product is installed by specialized and trained personnel;
- AFN doesn't take responsibility for changes made in the vehicle by its manufacturer;
- Work safely and use specialized tools at all times;
- **Always use protective gear.**



| Size | Torque Nm | Torque lbft |
|------|-----------|-------------|
| M6 | 9 Nm | 7 lbft |
| M8 | 22 Nm | 16 lbft |
| M10 | 44 Nm | 32 lbft |
| M12 | 77 Nm | 57 lbft |

Mouting Time

- 4 hours
- 2 persons (recommended)

Tools Required

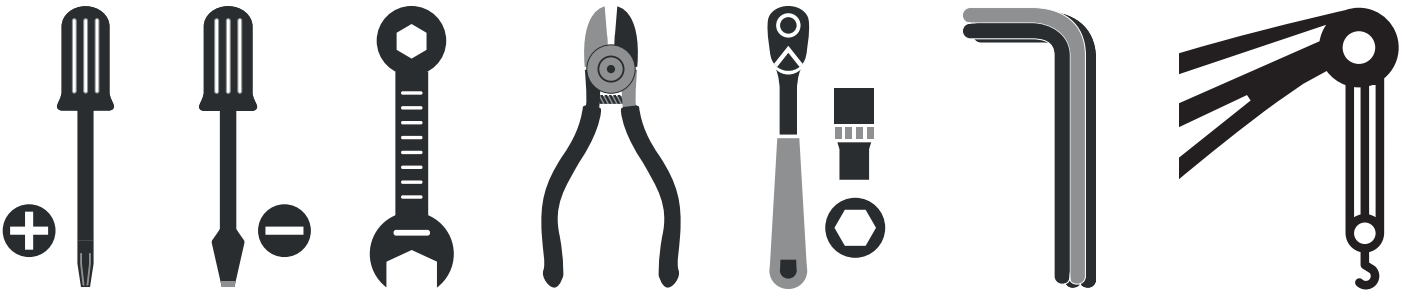

- Screwdriver star head
- Screwdriver flat head
- Wrench
- Wire cutter
- Ratchet wrench
- Allen wrench
- Crane

Step 1

Remove the OEM* bumper just as specified by the vehicle manufacturer in your maintenance manual. (Be aware that you must save the OEM bolts and nuts.)

Also remove the grill of the vehicle and be careful so you don't break the fasteners of the grill.



Step 2

Fit the **Winch Mount - 47001901** onto the **Chassis**.

Bolts needed:
1 - OEM* Bolt; 45000010 **x2**; **M10**

Repeat this step on the other side.

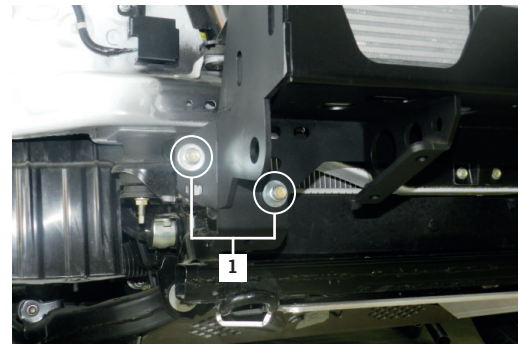
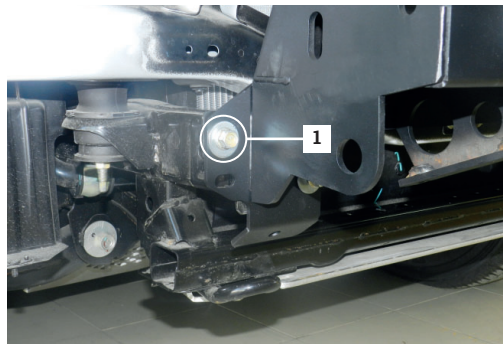

If you done it correctly this is what it should look like.

Just finger tight all bolts and nuts - **Do Not tighten yet.**

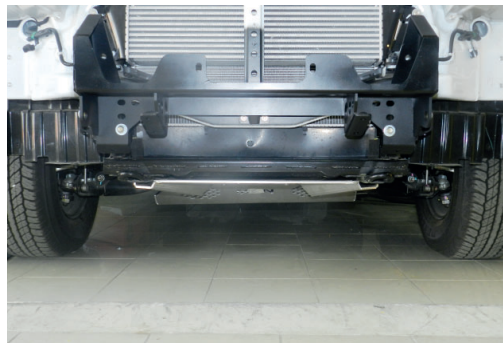

Finger tight these four, in order to firm the **Winch Bracket - 47001901** to the chassis.

Step 3

Fit part number **47001602** on the **inner side** of the **Winch Bracket**, as showed in the image.

Fit part number **46007184** on the **outer side** of the **Winch Bracket**, as showed in the image.

Bolts needed:
1 - 45000038; 45000010 **x2**;
45000017; **M10x80x30**

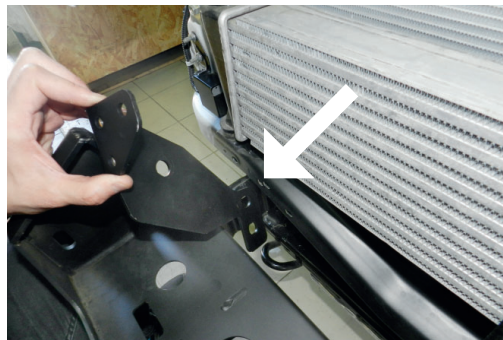

It must enter from above, between the **Winch Mount** and the chassis.

Just finger tight all bolts and nuts - **Do Not tighten yet.**

Step 4

Fit the other bolts on the **Winch Bracket**.

Bolts needed:
1 - 45000007; 45000010;
M10x30x1,5

Repeat this step on the other side.

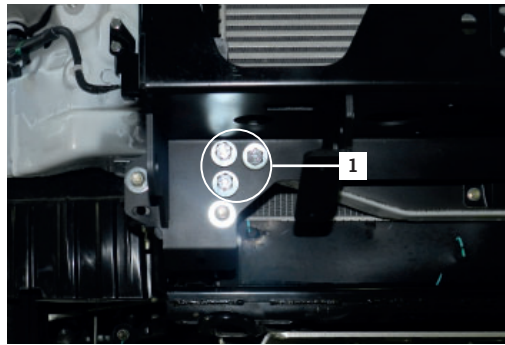

Step 5

Fit the other bolts on the **Reinforcement**. Bolts needed:

1 - 45000038; 45000010 x2;
 45000017; **M10x80x30**
2 - 45000007; 45000010 x2;
 45000017; **M10x30**
3 - 45000008; 45000011 x2;
 45000018; **M8x30**

Repeat this step on the other side.

Just finger tight all bolts and nuts - **Do Not tighten yet.**

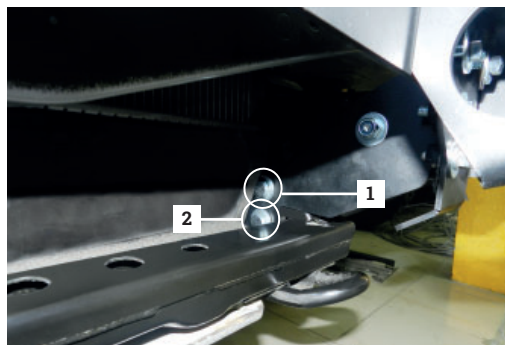

Step 6

Fix the **Winch Bracket** to the **Reinforcement - 46007183**.

Bolts needed:
1 - 45000067; 45000036 x2;
 45000066; **M12x30**

Repeat this step on the other side.

Just finger tight all bolts and nuts - **Do Not tighten yet.**

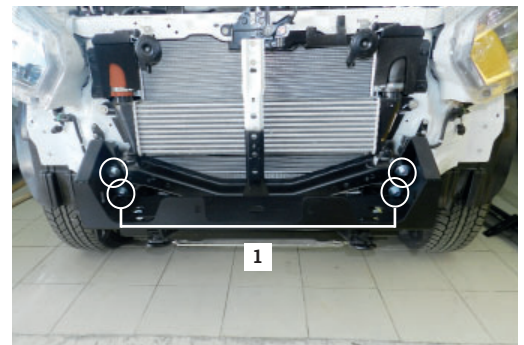
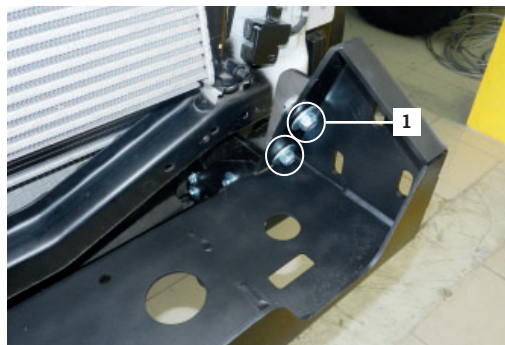

Step 7

Before inserting the **AFN Bullbar | Bumper** on the vehicle there are some details that we advise to do first (so, place it on a flat working surface):

Start by fitting the **45001113 - 1** on the **AFN Bullbar | Bumper**. Give a little push to correctly assemble them.

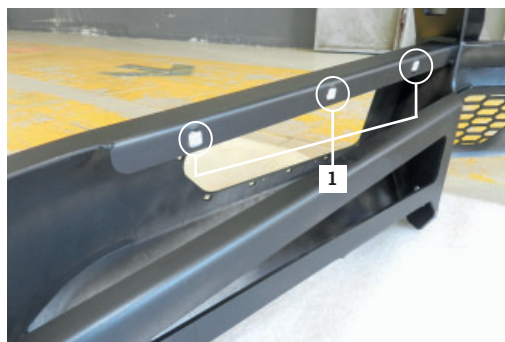

Step 8

While the Bullbar is still standing on a flat working surface, is time to fit the parts for the **Headlight Rubber - 46007274**.

Parts needed:

- 1 - 46007366;
- 2 - 45001123; 45001000;
- M3,5x16**
- 3 - 45001127;
- 4 - 46007274;

Follow the order as mentioned above.

Repeat this step on the other side for part **46007275**.

Fully tight then loose it a bit to have room to do some adjustments, on the **Headlight Rubber ref. 45001127**, if necessary.

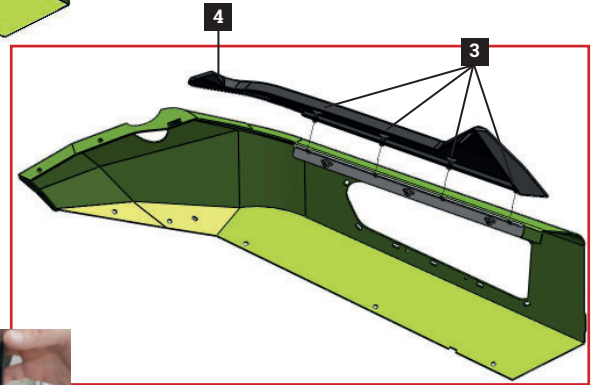
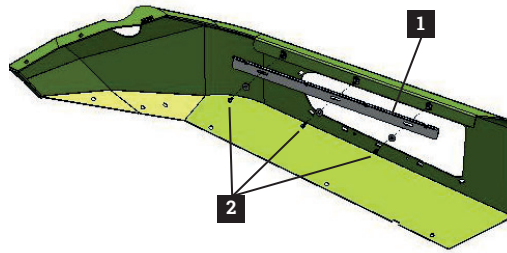

Step 9

Fit parts **46007276 - Rubbers**, on the AFN Bullbar | Bumper.

Parts needed:

- 1 - 45001127;
- 2 - 46007276;

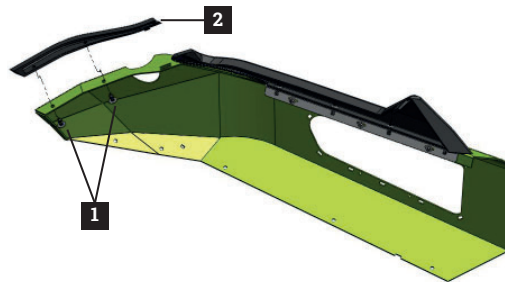

Add glue in between the rubbers - **46007276 and 46007274 - 46007275 and 46007277**.



Step 10

With help of another person or a crane, lift the **AFN Bullbar 48002395 | Bumper 48002424** and place it over the **Winch Bracket**.

Mind that this is a precision task, please take time to correctly assemble this step.

When the **AFN Bull Bar | Bumper** is in place, start by tightening all the bolts.

Bolts needed:

1 - 45000067; 46007001 **x2**;
45000066; **M12x35**

Before giving the final torque, adjust the best way the AFN Bullbar | Bumper to the body and chassis.

Use the supplied shims (**46007401**) to adjust the best way the Bull Bar | Bumper to the body and chassis.

We recommend to use the supplied shims if the **Bull Bar | Front Bumper** is not aligned with the body. Check the figure to fit them in the right places.

Give the final torque on the winch bracket's bolts.

We highly recommend to follow this tightening order, once everything is in place.

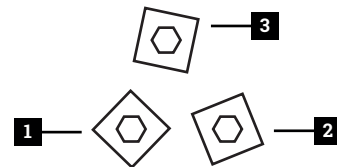
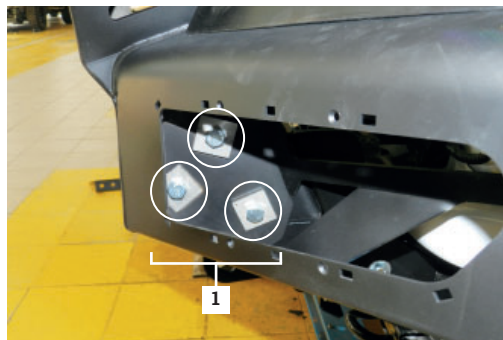
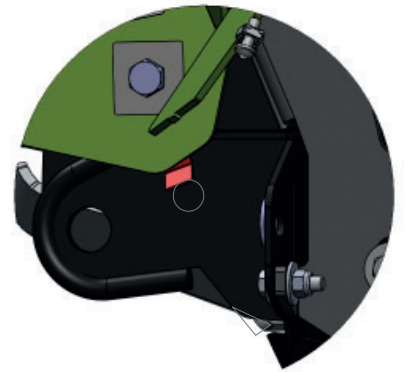
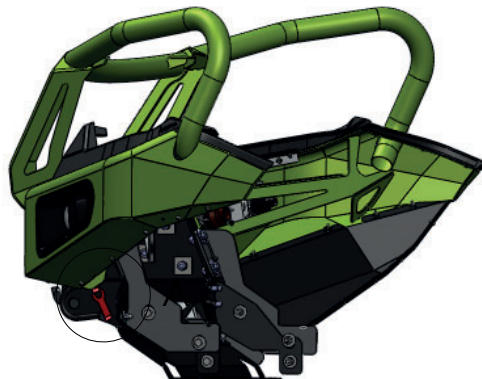

Keep this one always finger tight. It will only be fully tightened when all the bolts on the Winch Bracket and the bumper are.

Step 11

Fit part **46005518 - Plate Bracket**.

Bolts needed:

1 - 45001029; 45000995 **x2**;
45001033; **M12x40**

We do recommend using the supplied shims if the **Bull Bar | Front Bumper** is not aligned with the body. The shims must be fitted between the **Bull Bar | Front Bumper** and the **Winch Bracket**. Check the figure to fit them in the right place.

2 - 46007413 - thickness: 2mm
3 - 46007412 - thickness: 4mm

Use it only if you have to, they are optional and may not be needed.

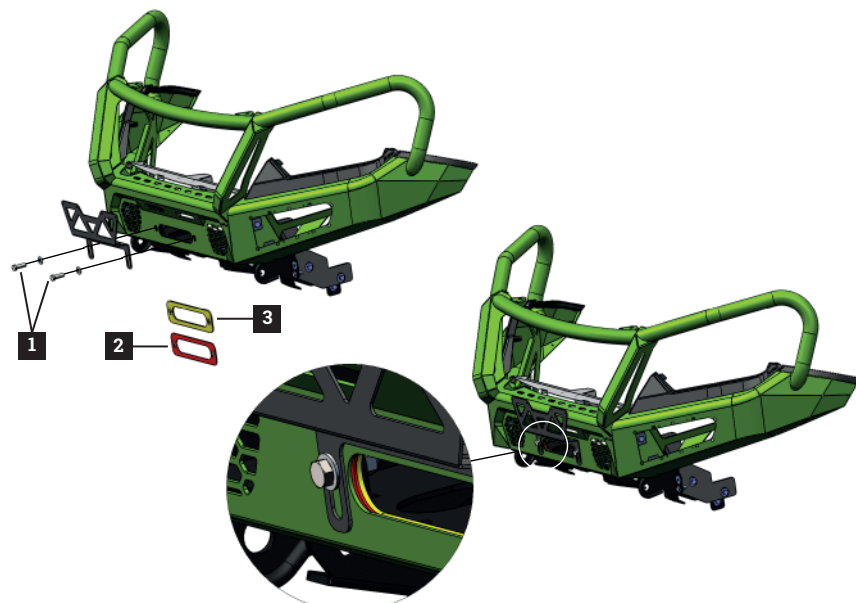

Step 11 (Continuation)

Once everything is in place and according to your personal preferences, **Give the final torque** on the bolts for part **46005518 - Plate Bracket**.

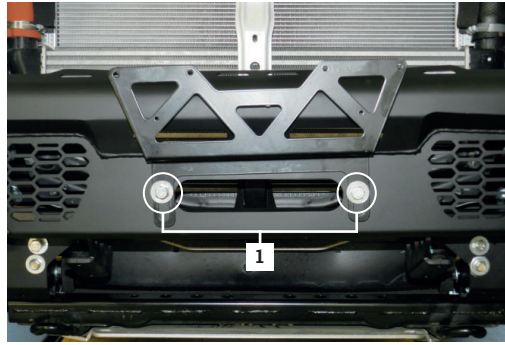

Step 12

Fit part **48002192** on the **AFN Bull Bar | Bumper**.

Bolts needed:
1 - 45000834; 45000276;
 45000274**;
M4x16
 Repeat this step for part **48002191**.



Fit the plastic cover of part **48002192** on the Bumper.

Bolts needed:
2 - 45001114; 45001113; **M3,5**
 Do the same on the other side for part **48002191**.

****NOTE:** These references for the Fog Lights, are not in this checklist, but they follow the kit **48002192** and **48002191**.

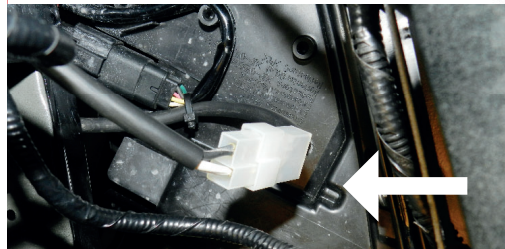
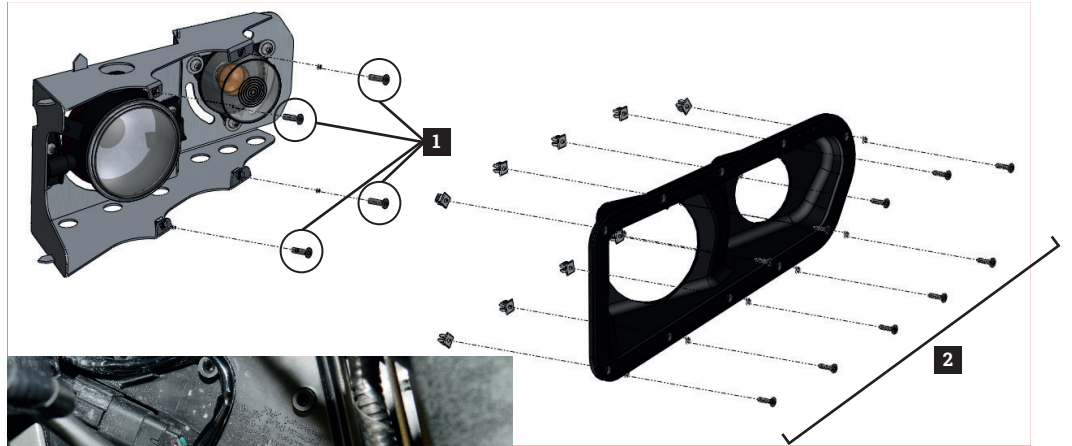

Step 13

Fit part **46007411 - Grill Bracket** on the OEM* grill, through the fasteners (see image).



Step 13 (Continuation)

Fit the OEM* grill on the **AFN Bullbar | Bumper**.

The grid must enter from above and gently rotate until it passes through. **Be careful so you don't break the fasteners of the grill.**

Fit part **46007411 - Grill Bracket** on the vehicle.

Bolts needed:
1 - 45000500; 45000294
M6x35

Once the grill is in place, reuse the OEM* bolts as showed on the image on the right.

2 - OEM* plastic bolts;
3 - OEM* plastic bolts;

Once the grill is in place, reuse the **4** OEM* plastic bolts as showed in the image on the right.

Give the final torque.

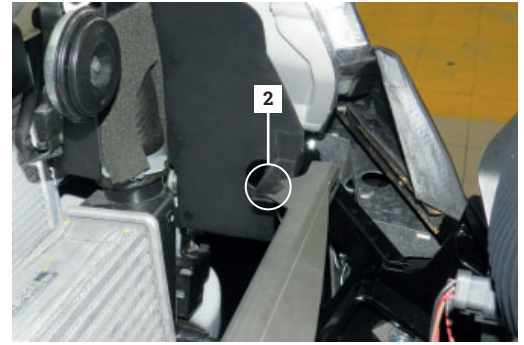
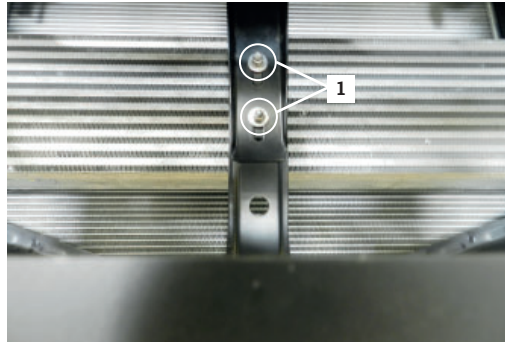

Please note that the part number **46007411 - Grill Bracket** must be fitted on the OEM* grill. (this is just an illustrative image)

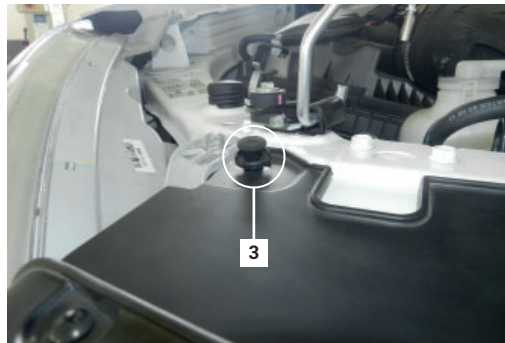

Step 14

Fit part **46007185**.

Finger tight all bolts and nuts before given the final torque.

Bolts needed:
1 - 45000998; 45000931;
 45001012; **M6**

Repeat this step on part **46007186**.

Do Not tighten yet.

Push the flaps **46007185** to OEM* plastic fenders and mark the cut line, then cut OEM* plastic fender. Mark a hole on the inner side of wheel fender from both left and right side of vehicle.

Drill a 2mm diameter hole. Fix the flaps through these holes using:

2 - 45001123; 45001113; **M3,5**

Repeat this step on part **46007186**.

Give the final torque.

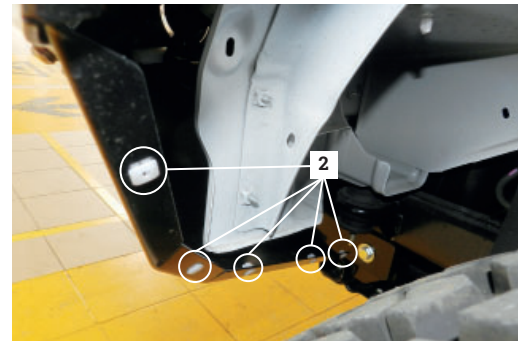
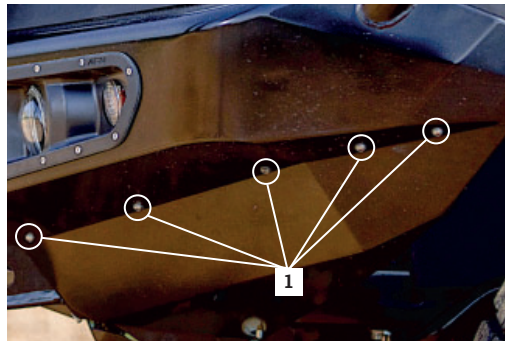

It's easier to install all the **45001113** before fitting the **46007185** and **46007186**.

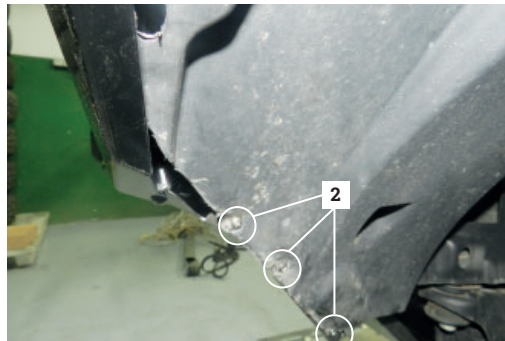

It's easier to cut plastic fender when the flaps are not installed.

Step 15

Fit underbody armour part **46007187**.

Bolts needed:

1- 45000934; **M10x30**

Fit underbody armour part **46007188**.

Bolts needed:

1- 45000934; **M10x30**

Give the final torque.

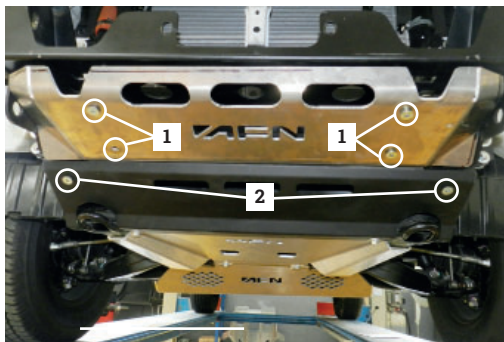

Step 16

Your new **AFN BULLBAR | FRONT BUMPER** is now installed on your **Isuzu D-MAX!**

Have Fun!



Reminder !

Before operating a vehicle fitted with an AFN Bullbar | Front Bumper:

- Make sure all fittings are tightened
- Check winch operation (if installed)
- Check all electrical wiring attached to lights and parking sensors (if installed)

Maintenance | Care

Periodically check and tighten all nuts. Stripped, fractured or bent bolts or nuts need to be replaced.



3 D-MAX CATALOGUE

AFN 4x4 Accessories is becoming a well known brand for its products due to its quality, design and safety which are challenged for thousands of people everyday, worldwide.

In its diversity of products we can include, with all-terrain quality, protection, safety and aesthetic accessories. With that being said, **AFN 4x4** has some other accessories that every offroad passionate would like to have, such as **Body Protections, Underbody Protections, Light Holders, Storage** (Wheel Supports and Jerry-can carriers) and others related to the **Aesthetics**.

We have some 4x4 accessories that combine with the original model lines that if you take a closer look you will see that they don't appear to be an accessory, but a must-have.

Please be in mind that some accessories are available only to some models.
 Feel free to check all the products that may interest you in our website at: www.afn.pt



Ref.: 48002396 - Front Bumper



Ref.: 48002395 - Bull Bar with fog lights



Ref.: 48002420 - Side Steps



Ref.: 48002339 - Rear Step Bar w/ trailer hitch



Ref.: 48002426 - Nerf Bars



Ref.: 48002188 - Rear Bumper w/ Wheel and Jerry-can carrier



Ref.: 48002205 - Front Skid Plate (*Al)

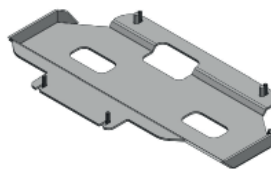

Ref.: 48002207 - Sump Guard Skid Plate (*Al)

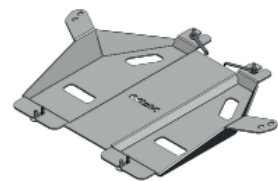

Ref.: 48002209 - Gearbox Skid Plate (*Al)

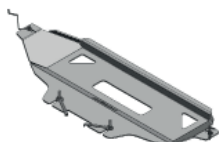

Ref.: 48002211 - Transfer Box Skid Plate (*Al)

4 WARRANTY TERMS

AFN4x4 products are warranted free from defects in materials and workmanship for a period of two (2) years from the date of initial retail purchase. Third-party components are delivered under the original manufacturer warranty.

Under the present warranty, **AFN4x4** obligation shall be limited to repairing, replacing or crediting, at its option, any part found to be defective.

AFN4x4 does not warrant or make any representations concerning its goods when:

- a) The products are purchased used, scratch and dent or when the box was opened.
- b) The products are not installed, used, and maintained strictly in accordance with **AFN4x4**'s instructions.
- c) The products are installed in vehicles that are used in competition.
- d) The products are installed in vehicles fitted with aftermarket non-standard tires with diameters in excess of OEM* specifications.
- e) The products are installed in vehicles with engines that have been modified to increase performance.

AFN4x4 will not be responsible for goods damaged in transit. If any goods arrive damaged, please contact the **AFN4x4** as soon as possible. **AFN4x4** will assess and may arrange to have the damaged goods returned to a **AFN4x4** Distributor and arrange for a replacement of the goods. Damaged goods must be returned in the condition received by you with all original packaging, accessories and/or manuals. If they are not returned in same condition sent there may be an additional fee charged.

To file a claim under this warranty please contact **AFN4x4** at +351 256 808 300 or via email at geral@afn.pt to request a *Returned Goods Authorization (RGA)* number and instructions for returning the defective component.

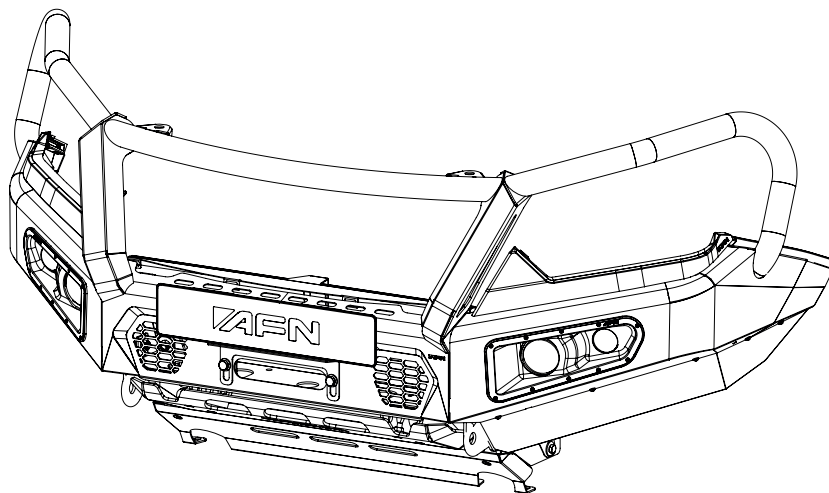



5 AFN 4x4 PARTNERS



01

Portugal

Rua da Madeira, 113
Z. Industrial das Travessas
3700-176 S. João da Madeira

T:(00351) 256 838 300/7
geral@afn.com
www.afn.com

02

Espanha

Carretera de Moledo 8
pol. ind. de Miraflores, Nave 20
36214, Vigo (Pontevedra)

T:(0034) 986 378338
info@4x4misutonida.com
www.4x4misutonida.com

03

Austrália

19 Flinders Parade
North lakes
QLD 4509

T:(0061) 1300 236 494
sales@afn4x4.com.au
www.afn4x4.com.au

DON'T JUST SETTLE FOR THE SAME OLD BULL



WWW.AFN.PT | SALES@AFN.PT | FACEBOOK.COM/AFN4X4

WELCOME TO THE AFN FAMILY



União Europeia
Fundo Europeu de
Desenvolvimento Regional

