

# CRAFTED LIKE NO OTHER

DON'T JUST SETTLE  
FOR THE SAME  
OLD BULL



**OWNER MANUAL**

TOYOTA  
PRADO 120 2004+

**AFN**<sup>®</sup>  
4 X 4 ACCESSORIES

## WELCOME TO THE AFN FAMILY

This manual contains the Toyota PRADO 120 +2004 fitting instructions for:  
Front Bumper Ref.: 48002405

# 1 INTRODUCTION



## The Company

Founded in 1995, AFN - 4x4 Accessories dedicates itself to the production and commerce of all-terrain accessories. Its constant concern in its customers total satisfaction, and in the ideals of innovation and transformation have granted a position of notability both in the national and international panorama.

The only company in Portugal in the mass production of 4x4 accessories, relies on specialized and experienced technicians, with the most adequate knowledge, to an efficient response capability to its customers demands.

Thanks to the specialization in the several areas of design and manufacture and to a constant investment in technology, AFN has been broadening its wide range of products, without ever neglecting the quality factor.

## 4x4 Accessories

In its diversity of products we can include, with all-terrain quality, protection, safety and aesthetic accessories.

And it is here that AFN invest on the best technology, the best cut precision of the raw material, and the transformation of products with the quality recognized in the marketplace.

AFN has, at its disposal, resources to test and analyse the resistance of its products and stands in the front row regarding the European homologation of materials dedicated to all terrain.

The contact with the most important test laboratories for vehicles, both in England, Spain and Germany, provides AFN with the know-how to manufacture a wide range of quality products.

## Our Design Approach

AFN designs each accessory taking into consideration the original model lines and fitting points. We refuse to have a "one design fits all" solution and we are always looking forward to embrace new challenges on how to adjust a new product into a new model!

The days of just throwing on a bit of steel together to form a protection system are gone. AFN is leading the way modern vehicle protection components are manufactured. Other will follow, and it won't be long where the AFN approach to Styling, Fit, Form and Function will become the benchmark for all other manufacturers.





## INDEX

### AFN 4x4 Accessories

Product: **Front Bumper**

Part Ref.: **48002405**

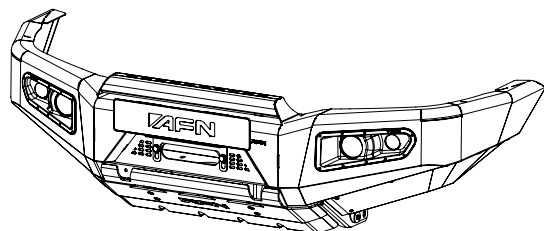

Introduction 2

1 Checklist 4  
Product 48002405

2 Fitting Instructions 7

3 PRADO 150 Catalogue 15

4 Warranty Terms 16

5 AFN 4x4 Partners 17



# 1 CHECKLIST

- In this section you have a checklist with all parts included for the installation of your AFN product
- This product should be installed as demonstrated in the product fitting instructions
- If verified that any component is damaged, please contact your nearest AFN distributor
- The specified parts will only fit in the models specified by AFN
- Do not modify any component of the product

This checklist is for product **48002405**.

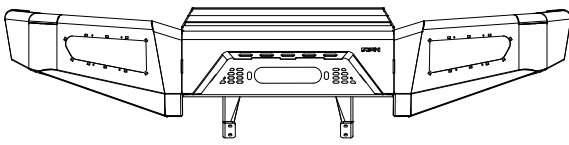

Ref.: 47002017



Ref.: 48002192  X1



Ref.: 48002191  X1



Ref.: 47002022  X2



Ref.: 47002021  X1



Ref.: 47002020  X1



Ref.: 47002019  X1



Ref.: 47002018  X1



Ref.: 46007689  X1



Ref.: 46007688  X1



Ref.: 46007684  X2



Ref.: 46007683  X1



Ref.: 46007682  X1



Ref.: 46007681  X1



Ref.: 46007680  X1



Ref.: 46005518  X1



**Stainless Steel**  
Ref.: 45001123  
M3,5x12  X10



Ref.: 45001113  X10  
M3,5

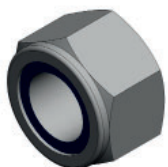

**Stainless Steel**  
Ref.: 45001033  
M12  X2



**Stainless Steel**  
Ref.: 45001029  
M12x40  X2

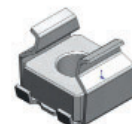

Ref.: 45001012  X18  
M6

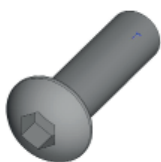

**Stainless Steel**  
Ref.: 45000998  
M6x20  X18

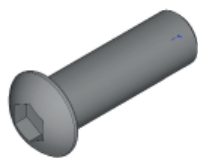

**Stainless Steel**  
Ref.: 45000996  
M8x25  X2



**Stainless Steel**  
Ref.: 45000995  
M12  X4

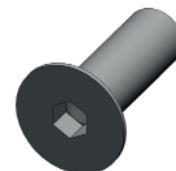

**Stainless Steel**  
Ref.: 45000934  
M10x30  X4



**Stainless Steel**  
Ref.: 45000931  
M6  X14



Ref.: 45000502  
2700 mm  X1

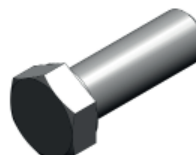

**Zinc Plated**  
Ref.: 45000067  
M12x35  X4

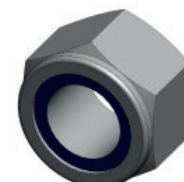

**Zinc Plated**  
Ref.: 45000066  
M12  X6



**Zinc Plated**  
Ref.: 45000048  
M8  X10



**Zinc Plated**  
Ref.: 45000044  
M6  X4



**Zinc Plated**  
Ref.: 45000036  
M12  X14



**Zinc Plated**  
Ref.: 45000028  
M8  X2

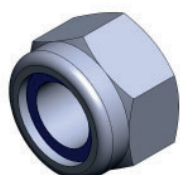

**Zinc Plated**  
Ref.: 45000018  
M8  X5

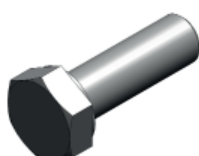

**Zinc Plated**  
Ref.: 45000014  
M8x25  X11



**Zinc Plated**  
Ref.: 45000011  
M8  X4

## 2 FITTING INSTRUCTIONS

**WARNING:**

Before you begin installation, read all instructions thoroughly. Proper tools will improve the quality of installation and reduce the time required.

- This product should be installed as demonstrated in the *Product «Fitting Instructions»*;
- The specified parts, will only fit the models specified by **AFN**;
- Do not modify any component of the product;
- It is recommended that this product is installed by specialized and trained personnel;
- AFN doesn't take responsibility for changes made in the vehicle by its manufacturer;
- Work safely and use specialized tools at all times;
- **Always use protective gear.**



Size	Torque Nm	Torque lbft
M6	9 Nm	7 lbft
M8	22 Nm	16 lbft
M10	44 Nm	32 lbft
M12	77 Nm	57 lbft

### Mouting Time

- 4 hours
- 2 persons (recommended)

### Tools Required

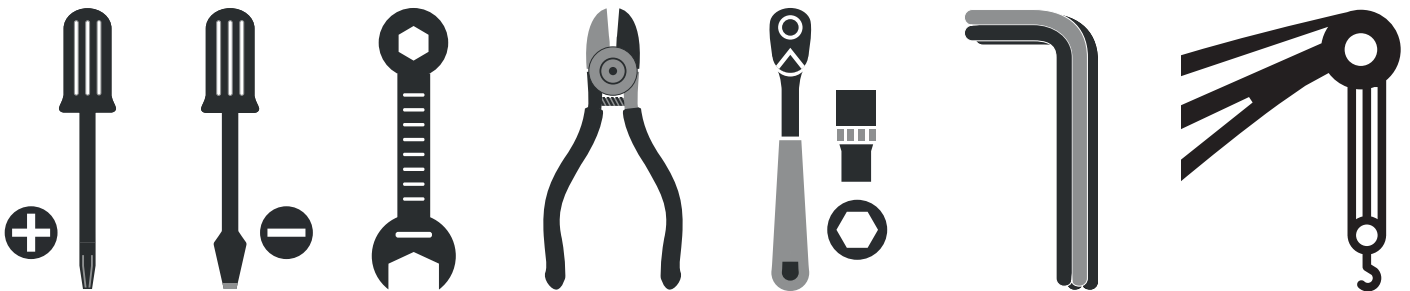

- Screwdriver star head
- Screwdriver flat head
- Wrench
- Wire cutter
- Ratchet wrench
- Allen wrench
- Crane

## Step 1

Remove the *OEM\** bumper just as specified by the vehicle manufacturer in your maintenance manual. (Be aware that you must save the *OEM* bolts and nuts.)

If you done it correctly this is what it should look like.



## Step 2

Before inserting the **AFN Bumper** on the vehicle there are some details that we advise to do first (so, place it on a flat working surface):

Start by fitting the **45001113** on the **AFN Bullbar | Bumper**. Give a little push to correctly assemble them.

**Do Not Full tight.**

Fit the plastic cover of part **48002192** on the Bumper.

Bolts needed:

**1** - \*\*;  
**2** - 45001114; 45001113; **M3,5**  
 Do the same on the other side for part **48002191**.

Remember to attach the electrical wires for the fog lights and indicators, once the **AFN Bullbar | Bumper** is fitted on vehicle.

We advise to do a test in order to check if all the lights are correctly working.

\*\*NOTE: These references for the Fog Lights, are not in this checklist, but they follow the kit **48002192** and **48002191**.

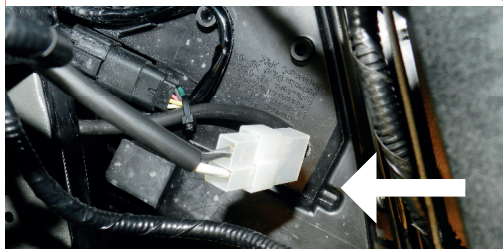
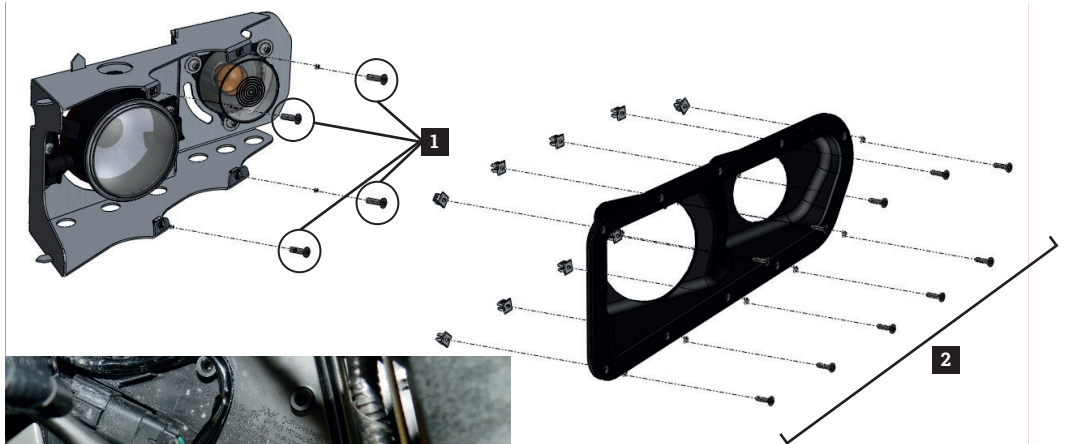
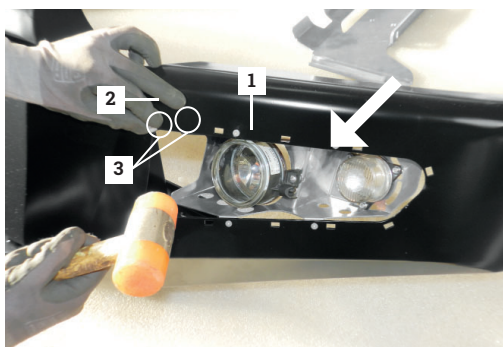

## Step 3

Fit part number **45000502 - Rubber**, into the **AFN Bumper**.

If you prefer, you may use a rubber mallet hammer to easily fit the rubber all the way into the **AFN Bullbar | Bumper**.



\*OEM - Original Equipment Manufacturer

## Step 4

Fit part number **47002020** on the vehicle chassis.

Parts needed:

- 1** - 46007684;
- 2** - OEM\* Bolt; OEM\* Nut; **M12**
- 3** - OEM\* Bolt; 45000036; OEM\* Nut; **M12**

Repeat this step on the other side for part number **47002021**.

Just finger tight all bolts and nuts - **Do Not tighten yet.**

If you done it correctly this is what it should look like.

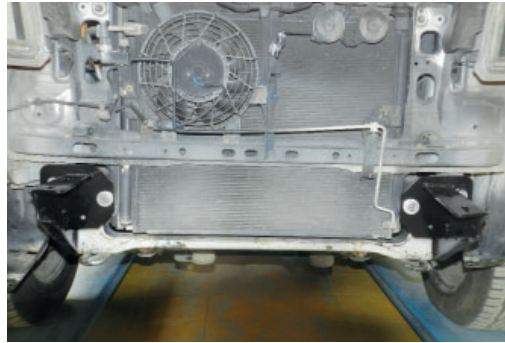
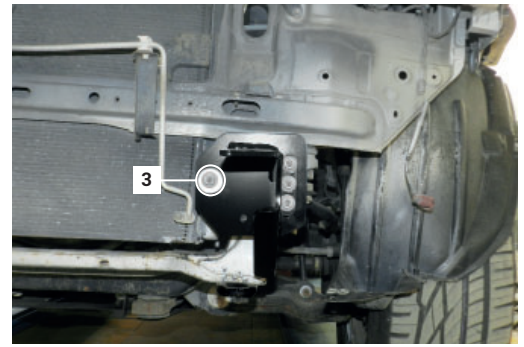
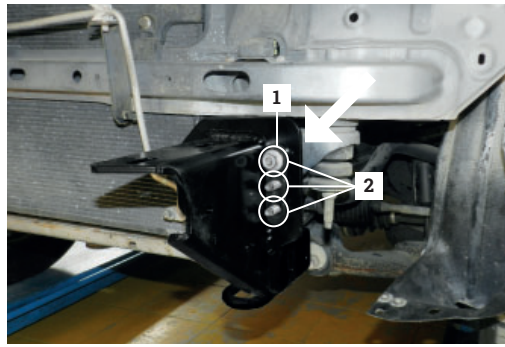

## Step 5

With help of another person or a crane, lift the **AFN Bumper 48002405** and place it over the **Chassis reinforcements, 47002020 and 471002021**.

Bolts needed:

- 1** - 45000067; 45000036 **x2**;
- 45000066; **M12**

Repeat this step on the other side.

Just finger tight all bolts and nuts - **Do Not tighten yet.**

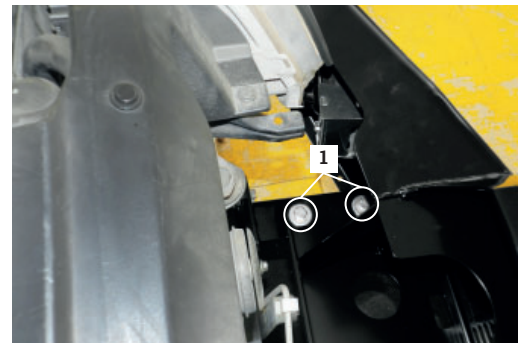

## Step 6

Fit the **Reinforcement - 47002018** connecting the **AFN Bumper 48002405** and the Vehicle chassis.

Bolts needed:

- 1** - 45000067; 45000036 **x2**;
- 45000066; **M12x35**
- 2** - 47002022;
- 3** - OEM\* Bolts;

Repeat this step on the other side.

Mind that this is a precision task, please take time to correctly assemble this step.

Just finger tight all bolts and nuts - **Do Not tighten yet.**

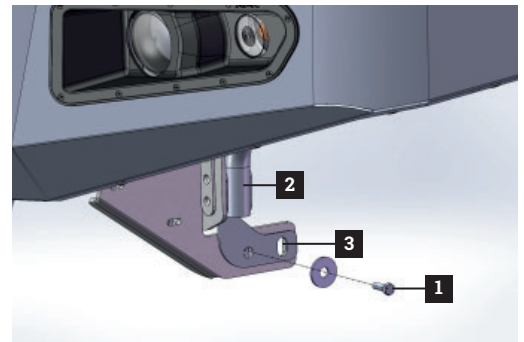
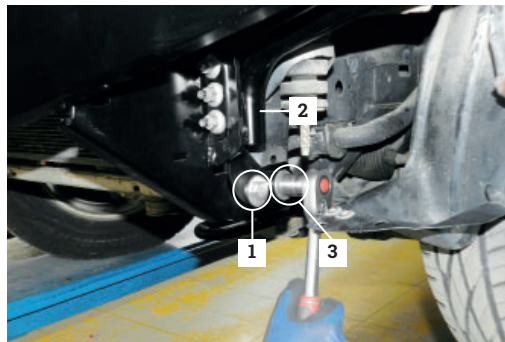



## Step 7

Adjust the **AFN Bumper** until you have almost **no gap** between vehicle body and the bumper on both sides.

Check to make sure the **AFN Bullbar | Bumper** is levelled. Please follow the order according our **Fitting Instructions Manual**.

**Give the final torque.**



## Step 8

Take on part number **46007682** and fit **two 45001012**, as showed.

Parts needed:  
**1** - 46007682;  
**2** - 45001012; **M6**

Before fitting part numbers **46007680** and **46007681** in the **AFN Bullbar | Bumper**, we do advise to fit first **46007680** and **46007682**. Please note in the "V" mark of part number **46007682**.

**3** - 45000998; **M6x20**

Repeat this step on the other side for part number **46007683** with **46007681**.

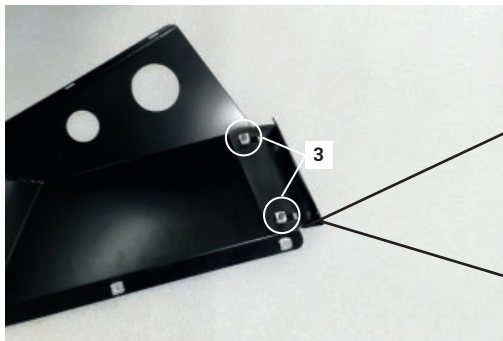
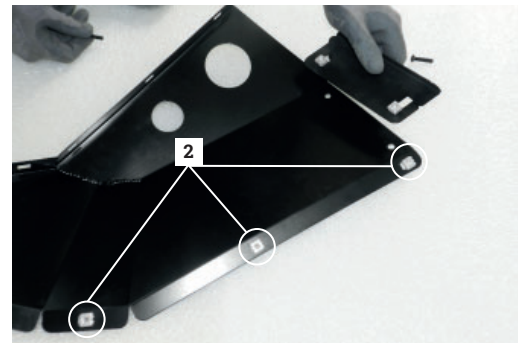
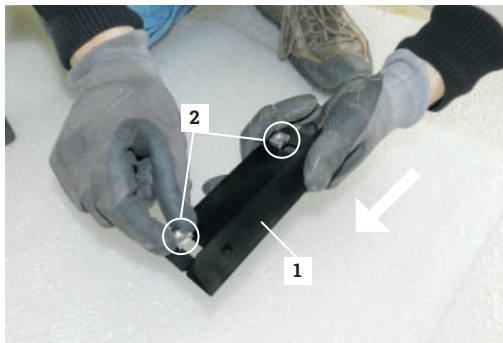

## Step 9

Fit part number **46007681** in the **AFN Bumper**.

Bolts needed:  
**1** - 45000998; 45000931; **M6**

Fit part number **46007683** into the **AFN Bullbar | Bumper**.

Bolts needed:  
**2** - 45000998; 45000931; **M6**

**Give the final torque.**

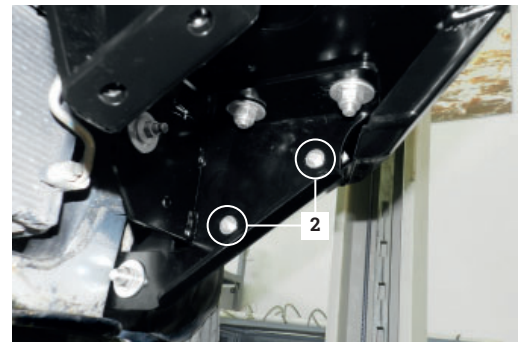
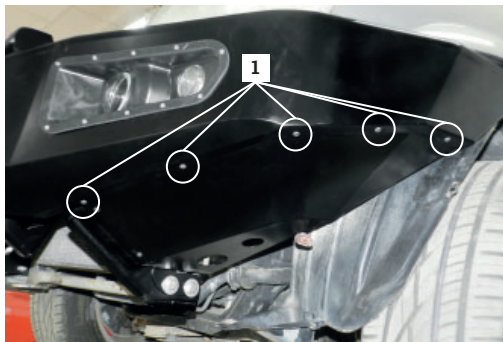

### Step 10

Push the flaps **46007681** to OEM\* plastic fenders and mark the cut line, then cut OEM\* plastic fender. Mark a hole on the inner side of wheel fender from both left and right side of vehicle. Drill a **2mm** diameter hole. Fix the flaps through these holes using:  
**3** - 45001123; 45001113; **M3,5**  
 Repeat this step on part **46007680**.

**Give the final torque.**

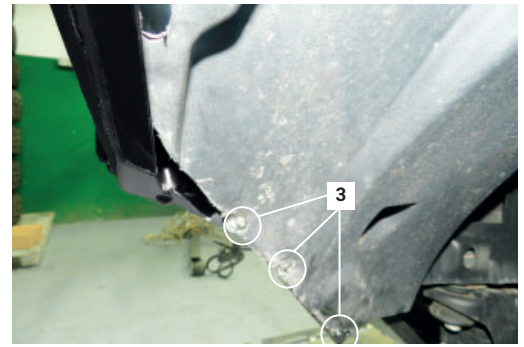

*It's easier to cut plastic fender when the flaps are not installed.*

### Step 11

Before fitting the underbody protections of the **AFN Bumper**, we do advise to fit both of them together first.  
 Parts needed:  
**1** - 46007689;  
**2** - 46007688;  
**3** - 45000014; 45000048;  
 45000018; **M8x25**

**Give the final torque.**

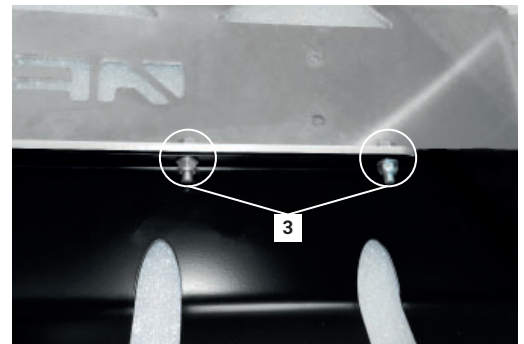
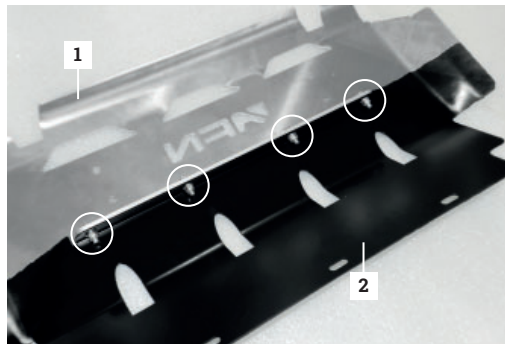

### Step 12

Fit both upper and lower underbody armours part number **46007688** and **46007689**.

Bolts needed:  
**1** - 45000934; **M10x30**  
**2** - 45000996; 45000028; **M8x25**

**Give the final torque.**

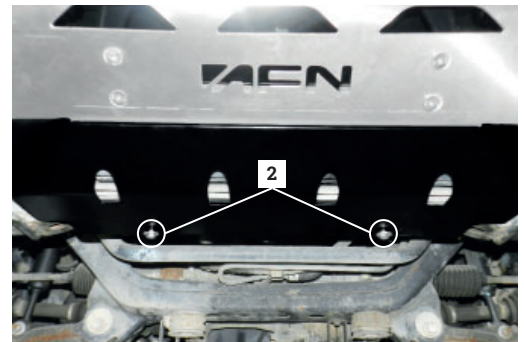
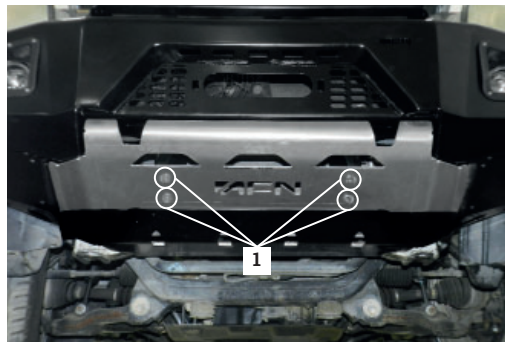

## Step 14

Your new **AFN FRONT BUMPER** is now installed on your **Toyota PRADO 120!**

Have Fun!



## Reminder !

Before operating a vehicle fitted with an **AFN Bullbar | Front Bumper**:

- Make sure all fittings are tightened
- Check winch operation (if installed)
- Check all electrical wiring attached to lights and parking sensors (if installed)

## Maintenance | Care

Periodically check and tighten all nuts. Stripped, fractured or bent bolts or nuts need to be replaced.

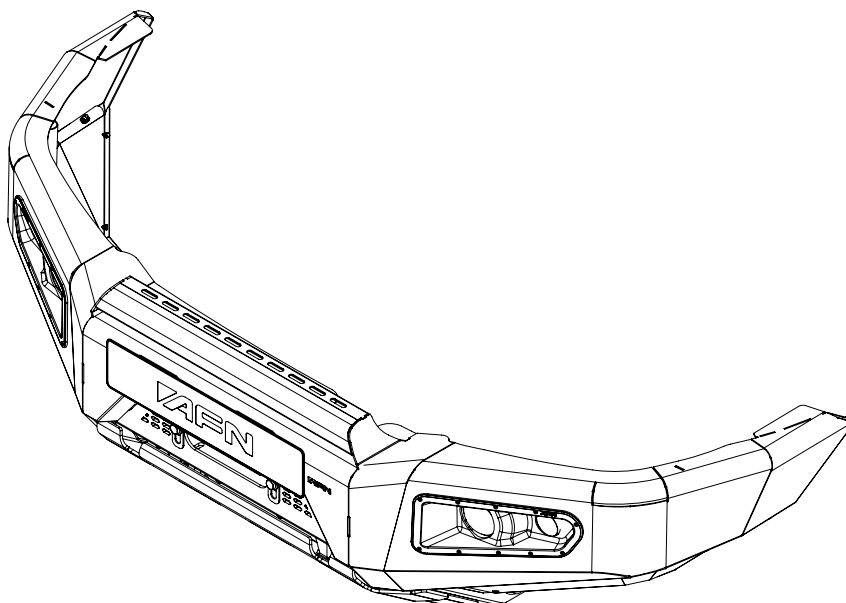

## 4 WARRANTY TERMS



**AFN4x4** products are warranted free from defects in materials and workmanship for a period of two (2) years from the date of initial retail purchase. Third-party components are delivered under the original manufacturer warranty.

Under the present warranty, **AFN4x4** obligation shall be limited to repairing, replacing or crediting, at its option, any part found to be defective.

**AFN4x4** does not warrant or make any representations concerning its goods when:

- a) The products are purchased used, scratch and dent or when the box was opened.
- b) The products are not installed, used, and maintained strictly in accordance with **AFN4x4**'s instructions.
- c) The products are installed in vehicles that are used in competition.
- d) The products are installed in vehicles fitted with aftermarket non-standard tires with diameters in excess of OEM\* specifications.
- e) The products are installed in vehicles with engines that have been modified to increase performance.

**AFN4x4** will not be responsible for goods damaged in transit. If any goods arrive damaged, please contact the **AFN4x4** as soon as possible. **AFN4x4** will assess and may arrange to have the damaged goods returned to a **AFN4x4** Distributor and arrange for a replacement of the goods. Damaged goods must be returned in the condition received by you with all original packaging, accessories and/or manuals. If they are not returned in same condition sent there may be an additional fee charged.

To file a claim under this warranty please contact **AFN4x4** at +351 256 808 300 or via email at [geral@afn.pt](mailto:geral@afn.pt) to request a *Returned Goods Authorization (RGA)* number and instructions for returning the defective component.

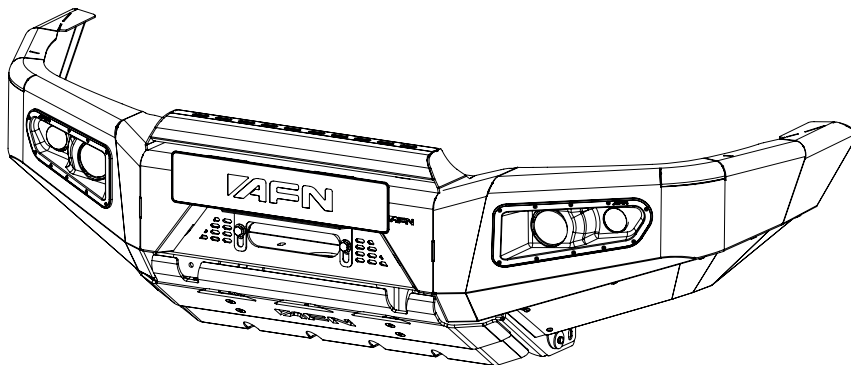

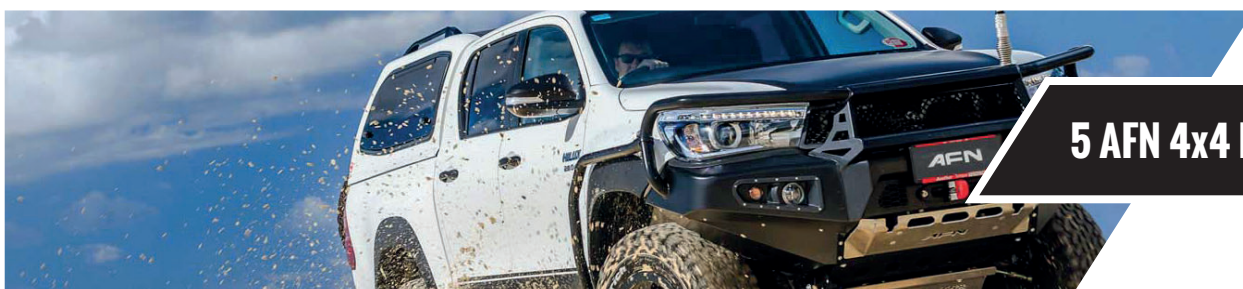

**5 AFN 4x4 PARTNERS**



**01**

**Portugal**

Rua da Madeira, 113  
Z. Industrial das Travessas  
3700-176 S. João da Madeira

T:(00351) 256 838 300/7  
geral@afn.com  
www.afn.com

**02**

**Espanha**

Carretera de Moledo 8  
pol. ind. de Miraflores, Nave 20  
36214, Vigo (Pontevedra)

T:(0034) 986 378338  
info@4x4misutonida.com  
www.4x4misutonida.com

**03**

**Austrália**

19 Flinders Parade  
North lakes  
QLD 4509

T:(0061) 1300 236 494  
sales@afn4x4.com.au  
www.afn4x4.com.au

**04**

**Costa Rica**

Fort overlanding CR,  
Alajuela

T:(0011) 506 8430 0211  
info@fortoverlanding.com  
www.fortoverlanding.com

DON'T JUST SETTLE FOR THE SAME OLD BULL



WWW.AFN.PT | SALES@AFN.PT | FACEBOOK.COM/AFN4X4

# WELCOME TO THE AFN FAMILY

