

CRAFTED LIKE NO OTHER

DON'T JUST SETTLE
FOR THE SAME
OLD BULL

OWNER MANUAL

Ford
Ranger PX 2016+

AFN
4 X 4 ACCESSORIES



This manual contains the
Ford Ranger PX +2016
fitting instructions for
Bull Bar Ref.: 48002380
Front Bumper Ref.: 48002394

WELCOME TO THE
AFN COMMUNITY

1 INTRODUCTION



The Company

Founded in 1995, AFN - 4x4 Accessories dedicates itself to the production and commerce of all-terrain accessories. Its constant concern in its customers total satisfaction, and in the ideals of innovation and transformation have granted a position of notability both in the national and international panorama.

The only company in Portugal in the mass production of 4x4 accessories, relies on specialized and experienced technicians, with the most adequate knowledge, to an efficient response capability to its customers demands.

Thanks to the specialization in the several areas of design and manufacture and to a constant investment in technology, AFN has been broadening its wide range of products, without ever neglecting the quality factor.

4x4 Accessories

In its diversity of products we can include, with all-terrain quality, protection, safety and aesthetic accessories.

And it is here that AFN invest on the best technology, the best cut precision of the raw material, and the transformation of products with the quality recognized in the marketplace.

AFN has, at its disposal, resources to test and analyse the resistance of its products and stands in the front row regarding the European homologation of materials dedicated to all terrain.

The contact with the most important test laboratories for vehicles, both in England, Spain and Germany, provides AFN with the know-how to manufacture a wide range of quality products.

Our Design Approach

AFN designs each accessory taking into consideration the original model lines and fitting points. We refuse to have a "one design fits all" solution and we are always looking forward to embrace new challenges on how to adjust a new product into a new model!

The days of just throwing on a bit of steel together to form a protection system are gone. AFN is leading the way modern vehicle protection components are manufactured. Other will follow, and it won't be long where the AFN approach to Styling, Fit, Form and Function will become the benchmark for all other manufacturers.





INDEX

AFN 4x4 Accessories

Product: **Bull Bar**

Part Ref.: **48002380**

Product: **Front Bumper**

Part Ref.: **48002394**

Introduction 2

1 Checklist 4

Product 48002380

Product 48002394

2 Fitting Instructions 7

3 Ranger PX Catalogue 16

4 Warranty Terms 17

5 AFN 4x4 Partners 18



1 CHECKLIST



- In this section you have a checklist with all parts included for the installation of your AFN product
- This product should be installed as demonstrated in the product fitting instructions
- If verified that any component is damaged, please contact your nearest AFN distributor
- The specified parts will only fit in the models specified by AFN
- Do not modify any component of the product

This checklist is for both product **48002380** and **48002394**.

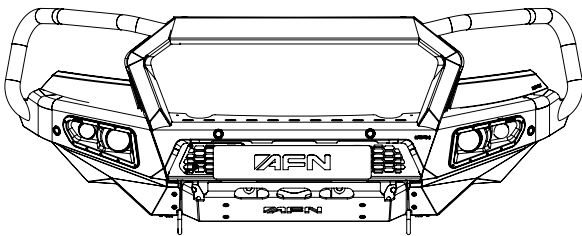

Ref.: 47001856

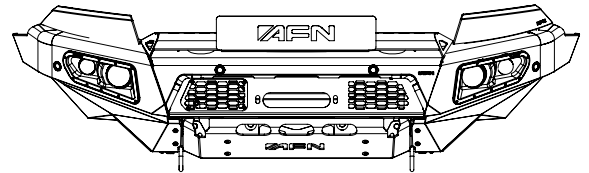

Ref.: 47001888



Ref.: 48002404

X4



Ref.: 48002390

X1



Ref.: 48002389

X1



Ref.: 47001860

X1



Ref.: 47001859

X1



Ref.: 47001858

X1



Ref.: 47001857

X1



Ref.: 47001483

X2



Ref.: 46007386
Thickness: 2 mm

X2



Ref.: 46007385
Thickness: 4 mm

X2



Ref.: 46007041

X1



Ref.: 46007039

X1



Ref.: 46007038 X1



Ref.: 46007037 X2



Ref.: 46007036 X2



Ref.: 46007035 X2



Ref.: 46007034 X2



Ref.: 46007033 X2



Ref.: 46007032 X1



Ref.: 46007031 X1



Ref.: 46007029 X1



Ref.: 46007028 X1



Ref.: 46007027 X1



Stainless Steel
Ref.: 46007001
M12x40x40 X4



Stainless Steel
Ref.: 46007000
M10x40x40 X12



Ref.: 46005518 X1



Stainless Steel
Ref.: 46000341
M16x1,5x60 X2



Stainless Steel
Ref.: 45001124
M6x35 X3



Stainless Steel
Ref.: 45001123
M3,5x16 X6

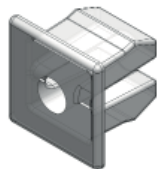

Ref.: 45001113 X6



Stainless Steel
Ref.: 45001040
M10x90x30 X2



Stainless Steel
Ref.: 45001033
M12 X2



Ref.: 45001012
M6 X12



Stainless Steel
Ref.: 45001002
M5 X4

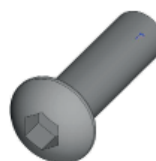

Stainless Steel
Ref.: 45000998
M6x20 X16

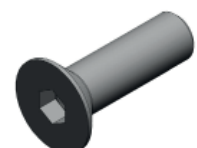

Stainless Steel
Ref.: 45000964
M6x20 X4



Stainless Steel

Ref.: 45000956
M10x25

X4

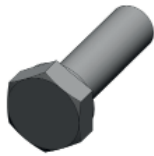

Stainless Steel

Ref.: 45000948
M6x20

X6



Stainless Steel

Ref.: 45000946
M5

X4

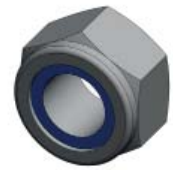

Stainless Steel

Ref.: 45000935
M10

X2



Stainless Steel

Ref.: 45000931
M6x15x1,6

X15



Stainless Steel

Ref.: 45000699
M12x90x35

X2



Ref.: 45000502

X2



Stainless Steel

Ref.: 45000500
M6

X10



Stainless Steel

Ref.: 45000400
M6

X6

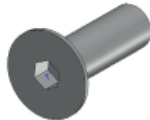

Stainless Steel

Ref.: 45000388
M5x16

X4



Stainless Steel

Ref.: 45000311
M10

X4

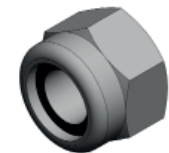

Stainless Steel

Ref.: 45000294
M6

X13

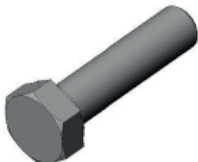

Zinc Plated

Ref.: 45000220
M10x40

X8



Zinc Plated

Ref.: 45000039
M10

X8

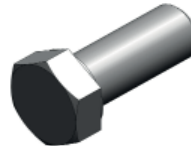

Zinc Plated

Ref.: 45000037
M12x30

X4



Zinc Plated

Ref.: 45000036
M12

X4



Zinc Plated

Ref.: 45000017
M10

X22



Zinc Plated

Ref.: 45000010
M10

X14

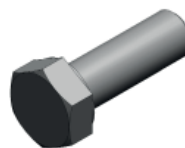

Zinc Plated

Ref.: 45000007
M10x30

X14

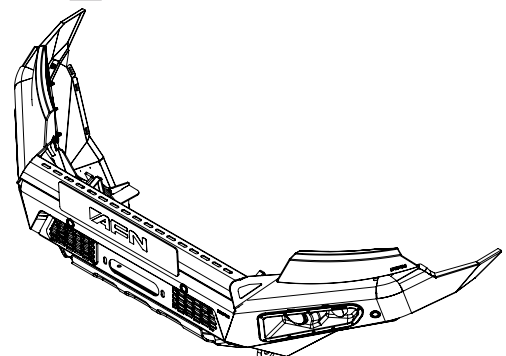
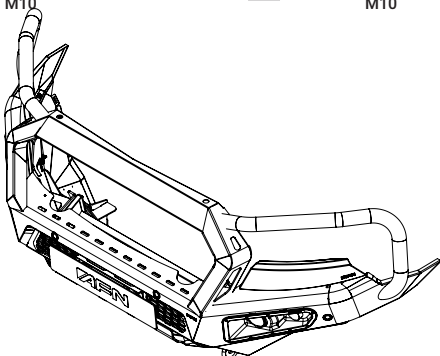



2 FITTING INSTRUCTIONS

WARNING:

Before you begin installation, read all instructions thoroughly.
Proper tools will improve the quality of installation and reduce the time required.

- This product should be installed as demonstrated in the *Product «Fitting Instructions»*;
- The specified parts, will only fit the models specified by **AFN**;
- Do not modify any component of the product;
- It is recommended that this product is installed by specialized and trained personnel;
- AFN doesn't take responsibility for changes made in the vehicle by its manufacturer;
- Work safely and use specialized tools at all times;
- **Always use protective gear.**



Size	Torque Nm	Torque lbft
M6	9 Nm	7 lbft
M8	22 Nm	16 lbft
M10	44 Nm	32 lbft
M12	77 Nm	57 lbft

Mouting Time

- 4 hours
- 2 persons (recommended)

Tools Required

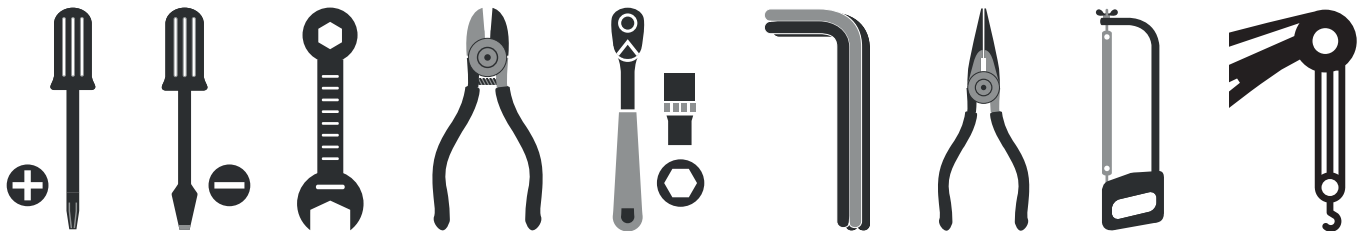

- Screwdriver star head
- Screwdriver flat head
- Wrench
- Wire cutter
- Ratchet wrench
- Allen wrench
- Needle plier
- Hacksaw
- Crane

Step 1

Remove the OEM* bumper just as specified by the vehicle manufacturer in your maintenance manual. *(Be aware that you must save the OEM bolts and nuts.)*

In order to be perfect, some adjustments needs to be done in the grill so, remove it aswell.

Be careful so you don't break the fasteners on the grill.



Step 2

After removing the grill, place it on a flat work surface. Once the basic measures are ready, it's time to do the curves that follow the AFN's bumper shape.

- 1** - 10 cm | 3.94 inches *(from edge to edge)*
- 2** - 9 cm | 3.54 inches *(from edge to edge)*
- 3** - 13 cm | 5.12 inches *(from edge to edge)*

Tip: we recommend the use of a hacksaw.

If you done it correctly this is what it should look like.



Step 3

Before inserting the AFN Bullbar on the vehicle there are some details that we advise to do first (so, place it on a flat working surface):

Take on part number **48002404 - Parking Sensor Bracket**, and remove the inner circle using an utility knife.



Only remove the inner circle if your vehicle has the Parking Sensor System installed.

Step 3 (Continuation)

Insert part number **48002404 - Parking Sensor Bracket** on the Bull Bar.

Check the image on the left to see how it's done.

If you prefer, you may use a needle plier.

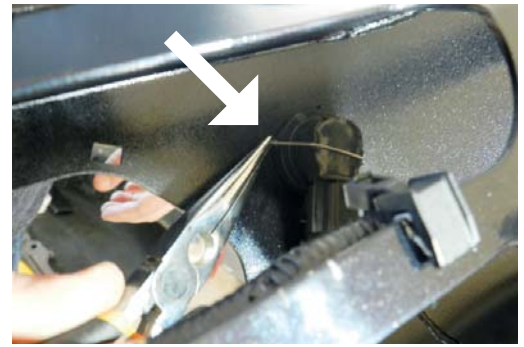

Check the image on the left to see how it must be look like.

Be aware to put the cables inside the space where it belongs, you may need some zip ties.



Step 4

While the Bullbar is still standing on a flat working surface, is time to fit the parts for the **Headlight Rubber - 46007038**.

Parts needed:

- 1** - 45000964; **M6x20**
- 2** - 46007035;
- 3** - 45000294; **M6**
- 4** - 46007037;
- 5** - 45000948; **M6x20**
- 6** - 46007038;
- 7** - 46007036;
- 8** - 45000294; **M6**

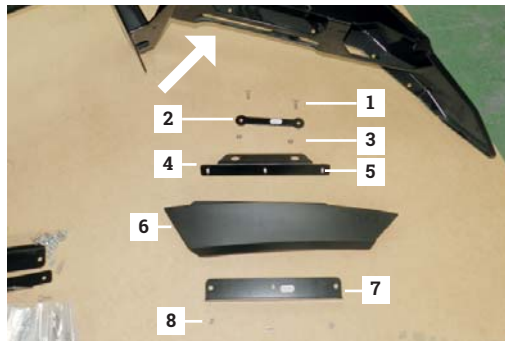

Follow the order as mentioned above.

Repeat this step on the other side for part **46007039**.

Fully tight then loose it a bit to have room to do some adjustment, on **ref. 45000964**, if necessary.

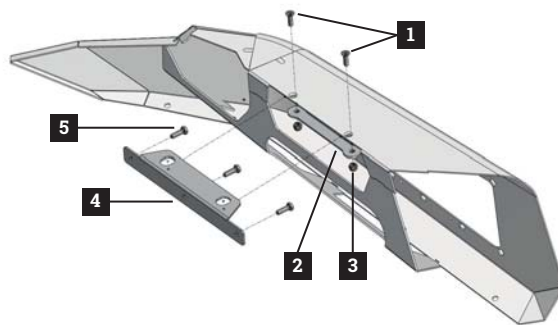

Tip: use a second wrench to prevent the null to rotate.

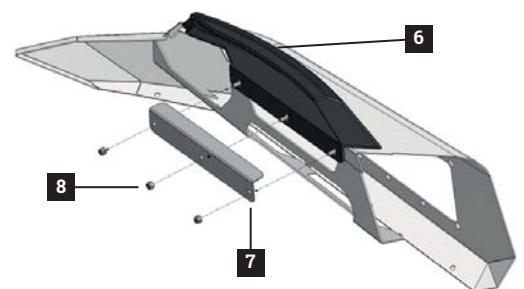

Step 5

Fit part **46007041** - grill.
Fit the **Adaptive Cruiser Control Sensor**** between the washers (see number **2** - **45000500**)

Bolts needed:
1 - 45000388; 45001002;
45000946; **M6**
2 - 45001124; 45000500;
45000400; 45000294; **M6**

3 - Adaptive Cruiser Control Sensor

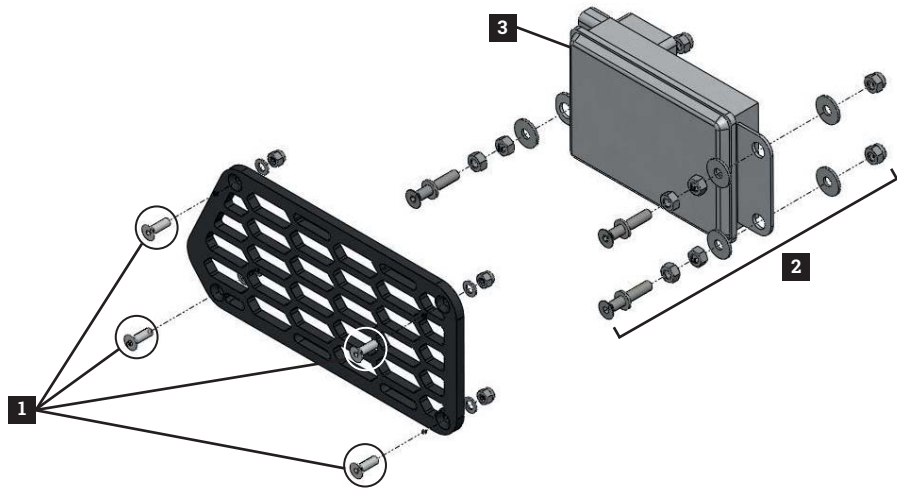

Give the final torque.

***NOTE: This step only applies for vehicles which have the Adaptive Cruiser Control Sensor. If not, you can skip it.*

4 - Air Temperature Sensor

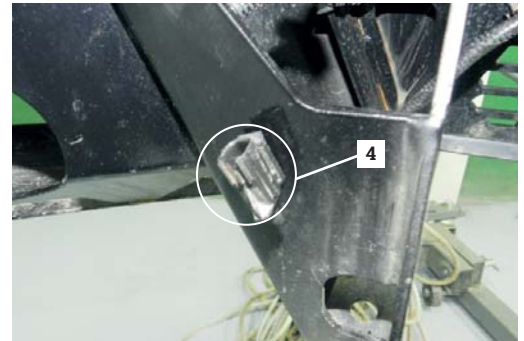
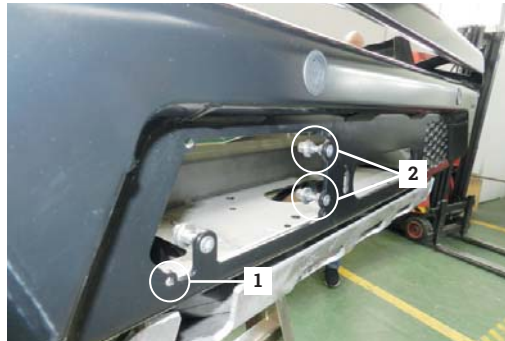

Step 6

Be sure that all the cables won't be crushed and are correctly fitted in the appropriate spaces. You may need some zip ties.

Fit part **45000502** - Rubbers and attach them on the **AFN Bull Bar 48002380 | Bumper 48002394**.



Step 7

Fit part **47001858** - Reinforcement for the **AFN Bullbar**.

Fit parts **46007034**, one on each side, on **Reinforcement 47001858**.

Remind to finger tight all bolts and nuts - **Do Not tighten yet.**

Bolts needed:
1 - 45000007; 45000010;
45000017; **M10x30**

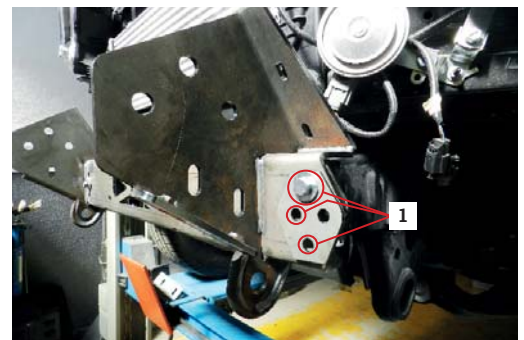
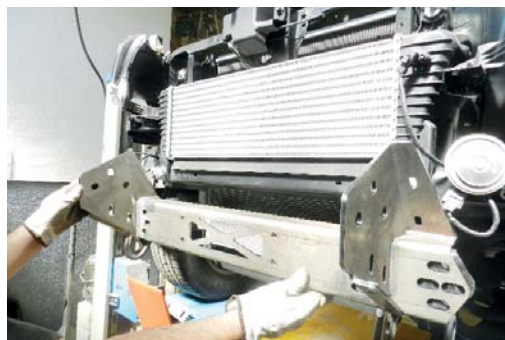

Step 7 (Continuation)

Fit parts **46007033**, one on each side, on the **Rear Reinforcement 47001858**.

Bolts needed:

1 - 45000007; 45000010; 45000017; **M10x30**

2 - Reuse the OEM* Bolts.

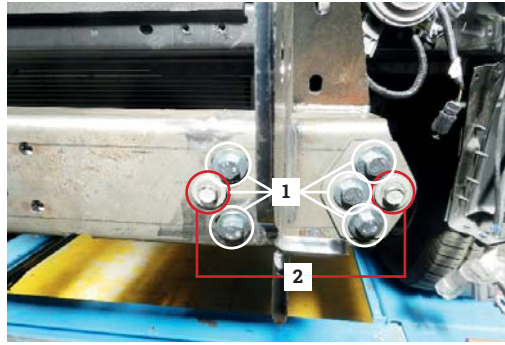

Step 8

Fit the **Winch mount - 47001857** on the **Reinforcement**.

Bolts needed:

1 - 45000037; 45000036; **M12x30**

Give the final torque.

Now fit the grill that have been previously trimmed.

Check the image on the right to see how it must be look like.

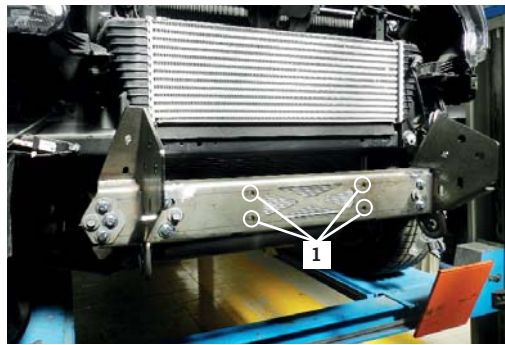

*If you are using a **Loopless Bumper**, you can fit the grill after you fit the Bumper.*

Step 9

Fit parts **46007032**, one on each side. Bolts needed:

1 - 46007032;
2 - 45000699; 46007001; 46000341; 45001033; **M12**

On the upper side of part **47001859**, fix it to chassis.

Bolts needed:

3 - 45000007; 45000017; 45000039; **M10**

With help of another person or a crane, lift the **AFN Bull Bar 48002380 | Bumper 48002394** and place it over the **Winch Bracket**.

Mind that this is a precision task, please take time to correctly assemble this step. Just finger tight all bolts and nuts - **Do Not tighten yet.**

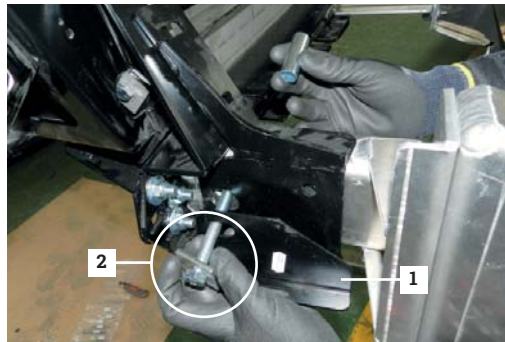

Step 9 (Continuation)

When the **Bull Bar | Bumper** is in place, start tightening all the bolts. If the gap between the chassis and body are not even with the Bull Bar | Bumper use the supplied shims. Bolts needed:

4 - 45000220; 45000010; 45000017; **M10**

5 - 45000220; 45007000; 45000017; **M10**

6 - 45000699; 46007001; 46000341; 45001033; **M12**

7 - 45000220; 46007000; 45000010; 45000017; **M10**

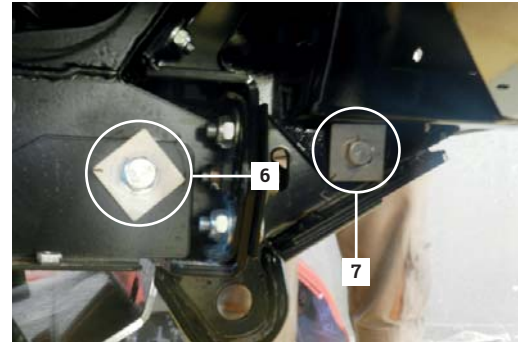
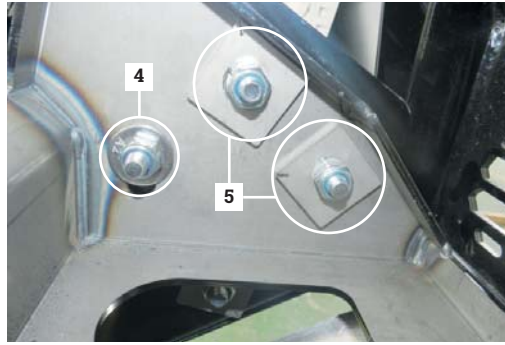

Step 10

Once the **AFN Bull Bar 48002380 | Bumper 48002394** is placed, start connecting the electrical plug and fasteners for the parking sensor.

We advise to do a simple approach test in order to check if the sensors are correctly working.

Use the supplied shims with different thickness to adjust the best way the Bull Bar | Bumper to the body and chassis.

We recommend to use the supplied shims if the **Bull Bar | Front Bumper** is not aligned with the body, there are different thickness for the best align. Check the figure to fit them in the right places.

Give the final torque on the winch bracket's bolts.

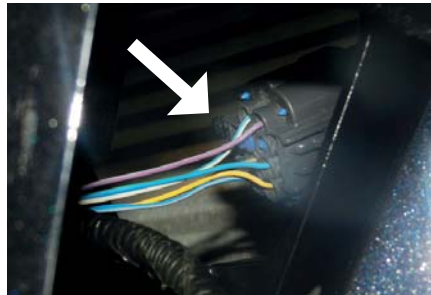

Step 11

This step only applies to the Bull Bar version, because in the Front Bumper there is enough space to fit the grill.

So, push the Bull Bar towards you and fit the grill. Once the grill is in place, reuse the OEM* bolts as showed on the image on the right.

Give the final torque.

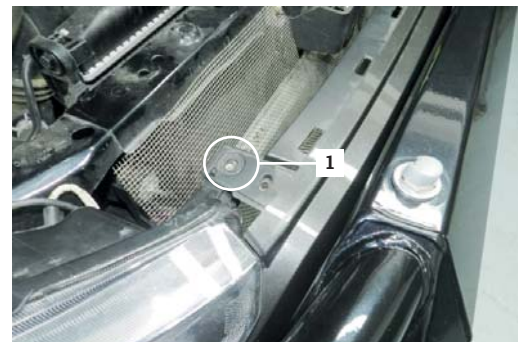

*OEM - Original Equipment Manufacturer

Step 12

Adjust bumper until you have an equal gap between vehicle body and the bumper on both sides.

Note: The gap must be almost the same size as the rubber's thickness - **45000502**.

Check to make sure the bullbar is levelled. Adjust if necessary and fully tighten all hardware.

Give the final torque.



Step 13

Once everything is in place and correctly fitted, drill a 12mm diameter hole on the chassis for an extra reinforcement when using the hi lift jack.

Bolts needed:
1 - 45001040; 45007000;
 45000935;

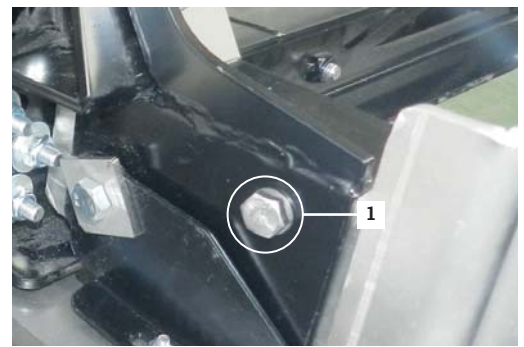

Step 14

Fit part **48002389** on the **AFN Bull Bar 48002380 | Bumper 48002394**. Bolts needed:
1 - 45000834; 45000949**;
M4
 Repeat this step for part **48002390**.

Fit the plastic cover of part **48002389** on the Bumper.
 Bolts needed:
2 - 45001114; 45001113; **M3,5**
 Do the same on the other side for part **48002390**.

****NOTE:** These references for the Fog Lights, are not in this checklist, but they follow the kit **48002389** and **48002390**.

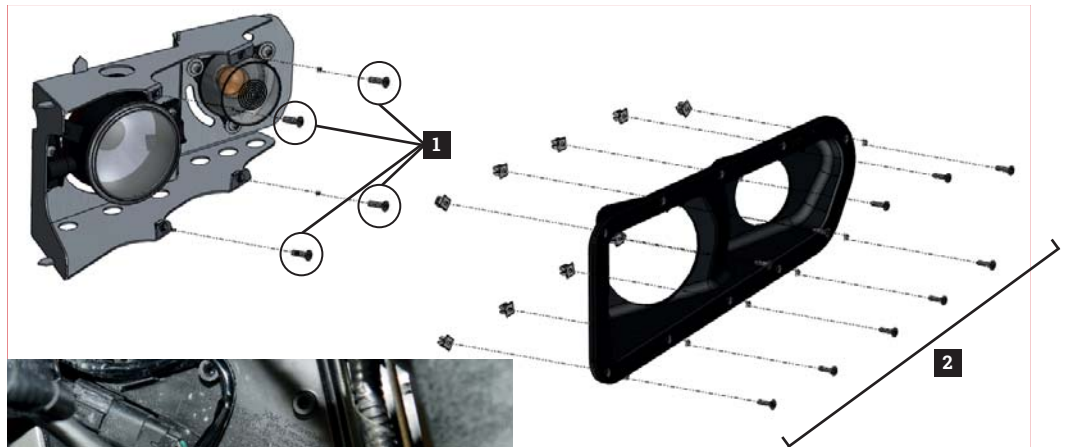
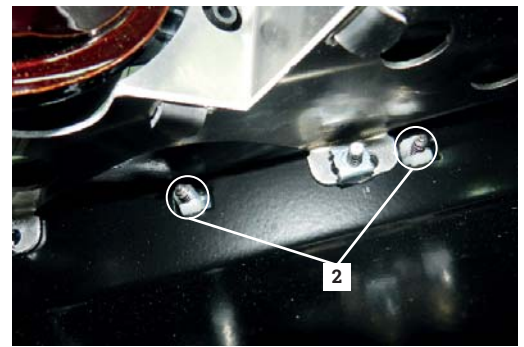

Once the light supports were fitted, reattach the electrical wires for the fog lights and indicators.

We advise to do a test in order to check if all the lights are correctly working.



Step 15

Fit part **46007027**.
Finger tight all bolts and nuts before given the final torque.

Bolts needed:
1 - 45000998; 45000931;
45001012; **M6**
2 - 45000998; 45000500; **M6**

Repeat this step on part **46007028**.

Do Not tighten yet.

Repeat this step on part **46007028**.

Give the final torque.

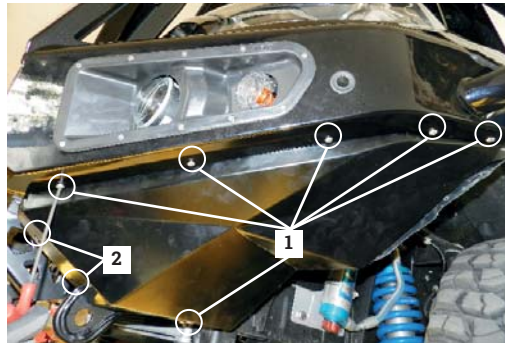
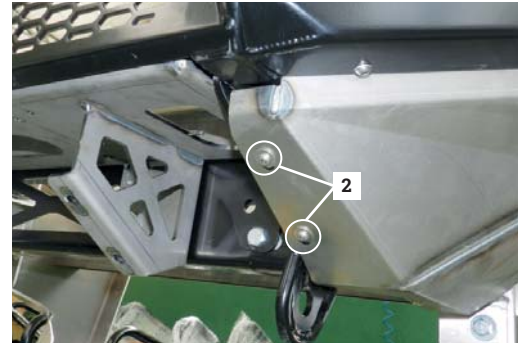

Step 16

Push the flaps **46007027** to OEM* plastic fenders and mark the cut line, then cut OEM* plastic fender. Mark a hole on the inner side of wheel fender from both left and right side of vehicle.

Drill a 2mm diameter hole. Fix the flaps through these holes using:

1 - 45001123; 45001113; **M3,5**
Repeat this step on part **46007028**.

Give the final torque.

Relocate the OEM* **Aerial Mast** with ref. number **EB3T-18A-886-BB** up, as shown in the image on the right.

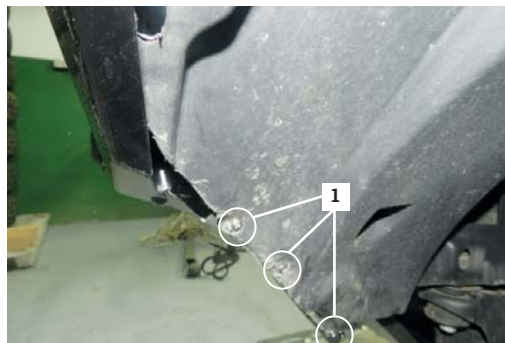

It's easier to cut plastic fender when the flaps are not installed.

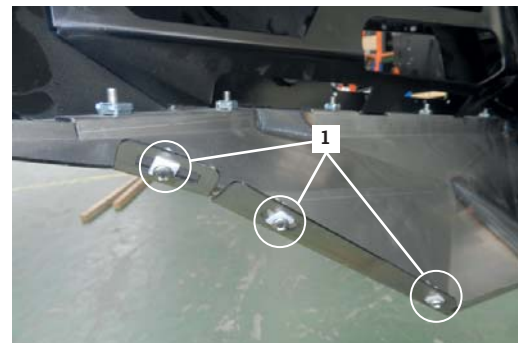

*It's easier to install all the **45001113** before fitting the **46007027** and **46007028**.*



Step 17

Fit underbody armour part **46007029**.

Bolts needed:

1- 45000956; **M10x25**

Give the final torque.



Step 18

Your new **AFN BULLBAR | FRONT BUMPER** is now installed on your **Ford Ranger**!

Have Fun!



Reminder !

Before operating a vehicle fitted with an AFN Bullbar | Front Bumper:

- Make sure all fittings are tightened
- Check winch operation (if installed)
- Check all electrical wiring attached to lights and parking sensors

Maintenance | Care

Periodically check and tighten all nuts. Stripped, fractured or bent bolts or nuts need to be replaced.



AFN 4x4 Accessories is becoming a well known brand for its products due to its quality, design and safety which are challenged for thousands of people everyday, worldwide.

In its diversity of products we can include, with all-terrain quality, protection, safety and aesthetic accessories. With that being said, **AFN 4x4** has some other accessories that every offroad passionate would like to have, such as **Body Protections, Underbody Protections, Light Holders, Storage** (Wheel Supports and Jerry-can carriers) and others related to the **Aesthetics**.

We have some 4x4 accessories that combine with the original model lines that if you take a closer look you will see that they don't appear to be an accessory, but a must-have.

Please be in mind that some accessories are available only to some models.
 Feel free to check all the products that may interest you in our website at: www.afn.pt



Ref.: 48002394 - Front Bumper



Ref.: 48002380 - Bull Bar with fog lights



Ref.: 48002393 - Side Steps



Ref.: 48002387 - Rear Step Bar w/ trailer hitch



Ref.: 48002397 - Nerf Bars



Ref.: 48002403 - Rear Bumper w/ Wheel and Jerry-can carrier



Ref.: 48002392 - Radiator Skid Plate (*Al)



Ref.: 48001831 - Sump Skid Plate (*Al)

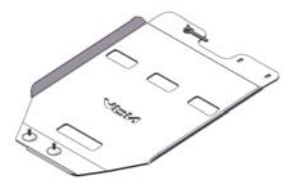

Ref.: 48001833 - Gearbox Skid Plate (*Al)



Ref.: 48001834 - Transfer Box Skid Plate (*Al)

4 WARRANTY TERMS



AFN4x4 products are warranted free from defects in materials and workmanship for a period of two (2) years from the date of initial retail purchase. Third-party components are delivered under the original manufacturer warranty.

Under the present warranty, **AFN4x4** obligation shall be limited to repairing, replacing or crediting, at its option, any part found to be defective.

AFN4x4 does not warrant or make any representations concerning its goods when:

- a) The products are purchased used, scratch and dent or when the box was opened.
- b) The products are not installed, used, and maintained strictly in accordance with **AFN4x4**'s instructions.
- c) The products are installed in vehicles that are used in competition.
- d) The products are installed in vehicles fitted with aftermarket non-standard tires with diameters in excess of OEM* specifications.
- e) The products are installed in vehicles with engines that have been modified to increase performance.

AFN4x4 will not be responsible for goods damaged in transit. If any goods arrive damaged, please contact the **AFN4x4** as soon as possible. **AFN4x4** will assess and may arrange to have the damaged goods returned to a **AFN4x4** Distributor and arrange for a replacement of the goods. Damaged goods must be returned in the condition received by you with all original packaging, accessories and/or manuals. If they are not returned in same condition sent there may be an additional fee charged.

To file a claim under this warranty please contact **AFN4x4** at +351 256 808 300 or via email at geral@afn.pt to request a *Returned Goods Authorization (RGA)* number and instructions for returning the defective component.

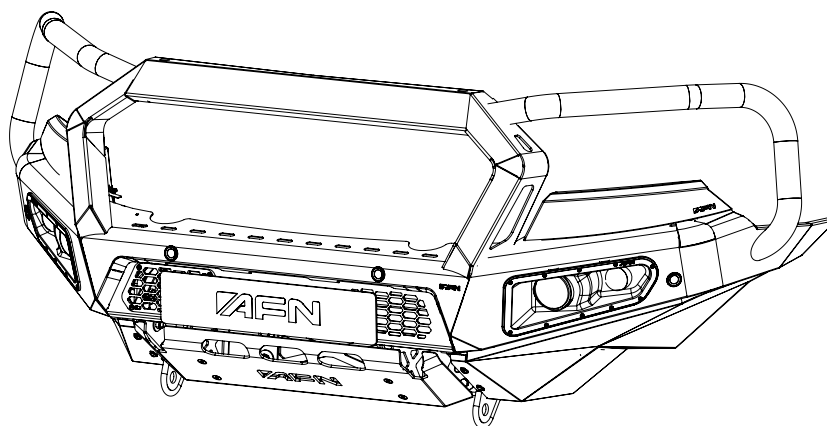



5 AFN 4x4 PARTNERS



01

Portugal

Rua da Madeira, 113
Z. Industrial das Travessas
3700-176 S. João da Madeira

T:(00351) 256 838 300/7
geral@afn.com
www.afn.com

02

Espanha

Carretera de Moledo 8
pol. ind. de Miraflores, Nave 20
36214, Vigo (Pontevedra)

T:(0034) 986 378338
info@4x4misutonida.com
www.4x4misutonida.com

03

Austrália

19 Flinders Parade
North lakes
QLD 4509

T:(0061) 1300 236 494
sales@afn4x4.com.au
www.afn4x4.com.au

DON'T JUST SETTLE FOR THE SAME OLD BULL



WWW.AFN.PT | SALES@AFN.PT | FACEBOOK.COM/AFN4X4

WELCOME TO THE AFN COMMUNITY



Made in PORTUGAL



Rua da Madeira, 113
Z. Industrial das Travessas
3700-176 S. João da Madeira
PORTUGAL

T: (00351) 256 838 300/7
F: (00351) 256 838 305
NIF: PT 503 495 042
geral@afn.pt | www.afn.pt