

# CRAFTED LIKE NO OTHER

DON'T JUST SETTLE  
FOR THE SAME  
OLD BULL

OWNER MANUAL

TOYOTA  
HILUX REVO 2015+

**AFN**<sup>®</sup>  
4 X 4 ACCESSORIES



## WELCOME TO THE AFN FAMILY

This manual contains the Toyota HILUX REVO +2015 fitting instructions for:  
Rear Step Bar Ref.: 48002304

# 1 INTRODUCTION

## The Company

Founded in 1995, AFN - 4x4 Accessories dedicates itself to the production and commerce of all-terrain accessories. Its constant concern in its customers total satisfaction, and in the ideals of innovation and transformation have granted a position of notability both in the national and international panorama.

The only company in Portugal in the mass production of 4x4 accessories, relies on specialized and experienced technicians, with the most adequate knowledge, to an efficient response capability to its customers demands.

Thanks to the specialization in the several areas of design and manufacture and to a constant investment in technology, AFN has been broadening its wide range of products, without ever neglecting the quality factor.

## 4x4 Accessories

In its diversity of products we can include, with all-terrain quality, protection, safety and aesthetic accessories.

And it is here that AFN invest on the best technology, the best cut precision of the raw material, and the transformation of products with the quality recognized in the marketplace.

AFN has, at its disposal, resources to test and analyse the resistance of its products and stands in the front row regarding the European homologation of materials dedicated to all terrain.

The contact with the most important test laboratories for vehicles, both in England, Spain and Germany, provides AFN with the know-how to manufacture a wide range of quality products.

## Our Design Approach

AFN designs each accessory taking into consideration the original model lines and fitting points. We refuse to have a "one design fits all" solution and we are always looking forward to embrace new challenges on how to adjust a new product into a new model!

The days of just throwing on a bit of steel together to form a protection system are gone. AFN is leading the way modern vehicle protection components are manufactured. Other will follow, and it won't be long where the AFN approach to Styling, Fit, Form and Function will become the benchmark for all other manufacturers.





## INDEX

### AFN 4x4 Accessories

Product: **Rear Step Bar w/ Trailer Hitch**

Part Ref.: **48002304**

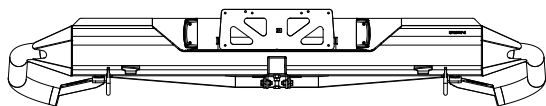

Introduction 2

1 Checklist 4  
Product 48002304

2 Fitting Instructions 6

3 D-MAX Catalogue 11

4 Warranty Terms 12

5 AFN 4x4 Partners 13



# 1 CHECKLIST



- In this section you have a checklist with all parts included for the installation of your AFN product
- This product should be installed as demonstrated in the product fitting instructions
- If verified that any component is damaged, please contact your nearest AFN distributor
- The specified parts will only fit in the models specified by AFN
- Do not modify any component of the product

This checklist is for product **48002304**.

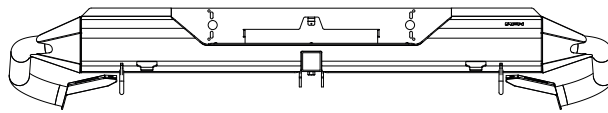

Ref.: 47001735



Ref.: 47001738  X1



Ref.: 47001737  X1



Ref.: 47001736  X1



Ref.: 47001233  X2

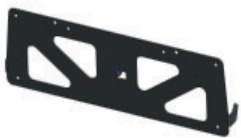

Ref.: 46007085  X1



Ref.: 45000641  X1



Zinc Plated  
Ref.: 45000315 M12x35  X6



Zinc Plated  
Ref.: 45000267 M12x40  X2



Zinc Plated  
Ref.: 45000074 M6  X2

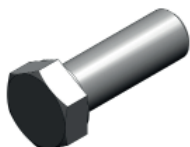

Zinc Plated  
Ref.: 45000067 M12x35  X12

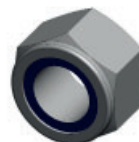

Zinc Plated  
Ref.: 45000066 M12  X12



Zinc Plated  
Ref.: 45000050 M6x15  X6



Zinc Plated

Ref.: 45000043  
M6x20

X2



Zinc Plated

Ref.: 45000042  
M12

X24



Zinc Plated

Ref.: 45000039  
M10

X4



Zinc Plated

Ref.: 45000036  
M12

X6



Zinc Plated

Ref.: 45000034  
M12

X2

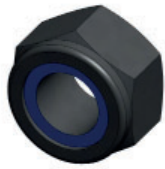

Zinc Plated

Ref.: 45000017  
M12

X12



Zinc Plated

Ref.: 45000010  
M10

X20



Zinc Plated

Ref.: 45000007  
M10x30

X12

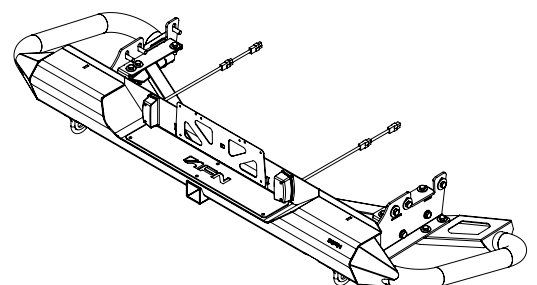

## 2 FITTING INSTRUCTIONS

**WARNING:**

Before you begin installation, read all instructions thoroughly.  
Proper tools will improve the quality of installation and reduce the time required.

- This product should be installed as demonstrated in the *Product «Fitting Instructions»*;
- The specified parts, will only fit the models specified by **AFN**;
- Do not modify any component of the product;
- It is recommended that this product is installed by specialized and trained personnel;
- AFN doesn't take responsibility for changes made in the vehicle by its manufacturer;
- Work safely and use specialized tools at all times;
- **Always use protective gear.**



Size	Torque Nm	Torque lbft
M6	9 Nm	7 lbft
M8	22 Nm	16 lbft
M10	44 Nm	32 lbft
M12	77 Nm	57 lbft

### Mouting Time

- 1 hour
- 2 persons (recommended)

### Tools Required

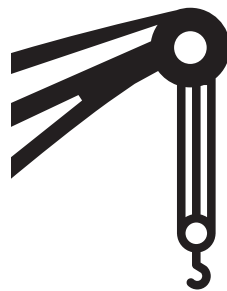
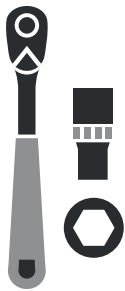

- Wrench
- Ratchet wrench
- Needle plier
- Crane

## Step 1

Remove the OEM\* rear bumper just as specified by the vehicle manufacturer in your maintenance manual. (Be aware that you must save the OEM bolts and nuts.)

Once everything is ready, it should look like the image on the right.



## Step 2

Before inserting the **AFN Rear Step** on the vehicle there are some details that we advise to do first (so, place it on a flat working surface):

Start by fitting the **47001233** on the **AFN Rear Step**.

Bolts needed:

**1** - Loosen the nuts from part **47001233** and fit it on the **AFN Rear Step**.

**Give the final torque.**

**2** - 45000043; 45000050 x3; 45000074; **M6x20**

**Do Not give the final torque.**

Fit **45000641 - Spring** between the **46007085 - Plate Bracket** and the **AFN Rear Step**.

If you done it correctly this is what it should look like.

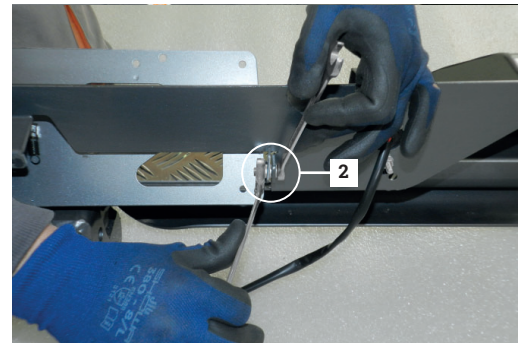

Please note the **45000050** between **Rear Step** and **Plate Bracket**.

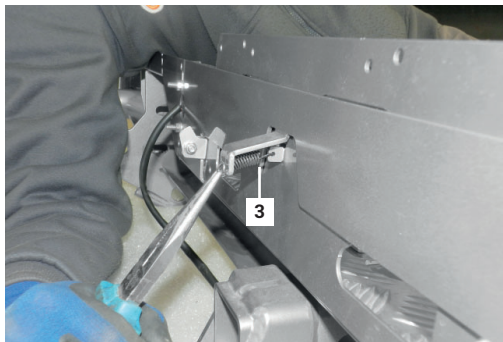

You may use a needle plier in order to help you fix the spring.

## Step 3

Fit part number **47001737** on the **vehicle chassis**, as showed in the image.

Bolts needed:

**1** - 45000007; 45000010 x2; 45000017; **M12**

Repeat this step on the other side for part **47001736**.

Just finger tight all bolts and nuts - **Do Not tighten yet.**

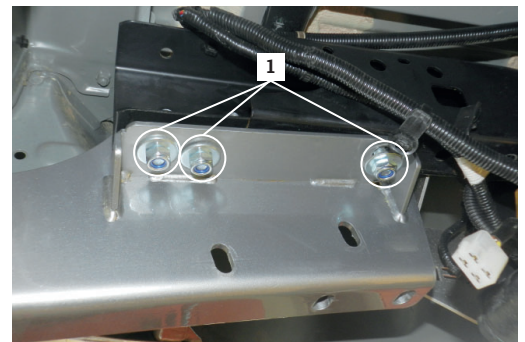
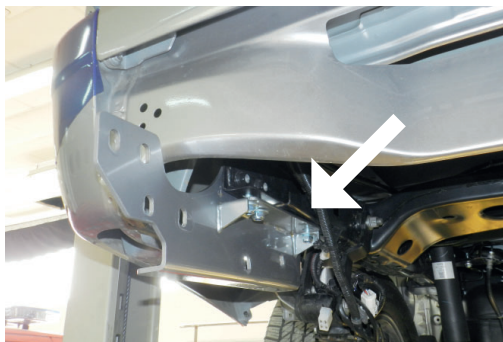

### Step 3

On part number **47001737** there are still three more to fit on the **vehicle chassis**, as showed in the image.

Bolts needed:  
**2** - 45000315; 45000036; **M12x30**

Repeat this step on the other side for part **47001736**.

Give the final torque.

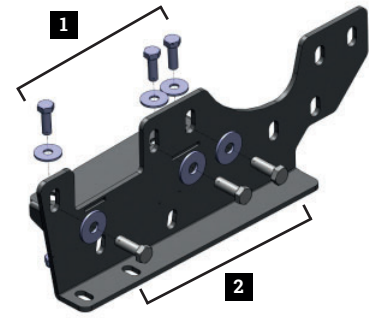
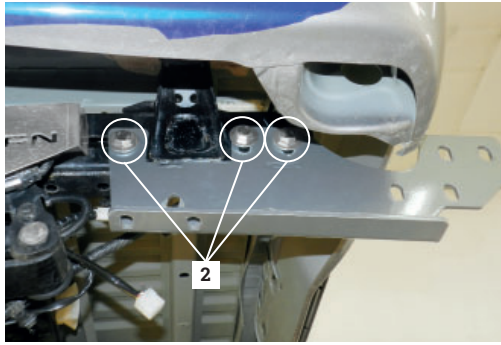

### Step 4

With help of another person or a crane, lift part number **47001735 - AFN Rear Step** and place it into the part number **47001736** and **47001737**.

Mind that this is a precision task, please take time to correctly assemble this step.

When the **AFN Rear Step** is in place, start by tightening all the bolts.

Bolts needed:  
**1** - 45000067; 45000042 **x2**;  
 45000066; **M12x35**  
**2** - 45000007; 45000010 **x2**;  
 45000017; **M10x30**

Just finger tight all bolts and nuts - **Do Not tighten yet.**

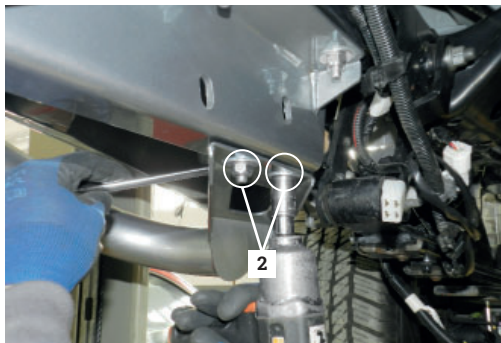
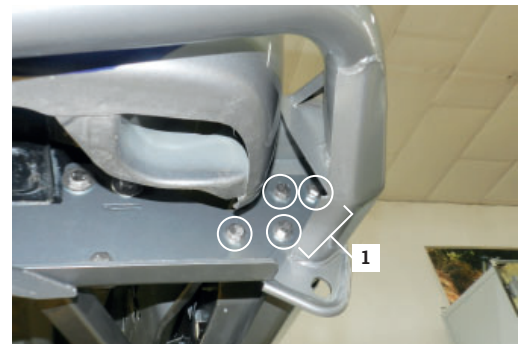

### Step 5

Fit part number **47001738 - Reinforcement** on both parts **47001736** and **47001737** as showed in the image.

Bolts needed:  
**1** - 45000067; 45000042 **x2**;  
 45000066; **M12x35**

Just finger tight all bolts and nuts - **Do Not tighten yet.**

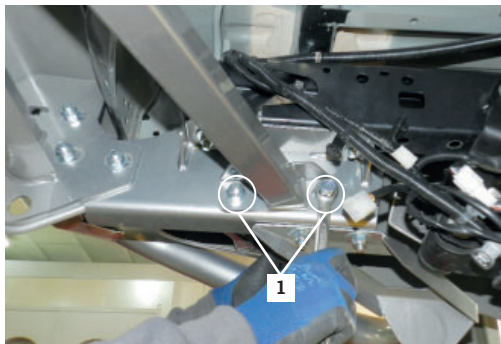



## Step 5

Fit part number **47001738 - Reinforcement** on the **AFN Rear Bumper** as showed in the image.

Bolts needed:

**2** - 45000007; 45000039 **x2**;  
45000017; **M10x30**

Adjust the **AFN Rear Step** the best way.

**Give the final torque.**

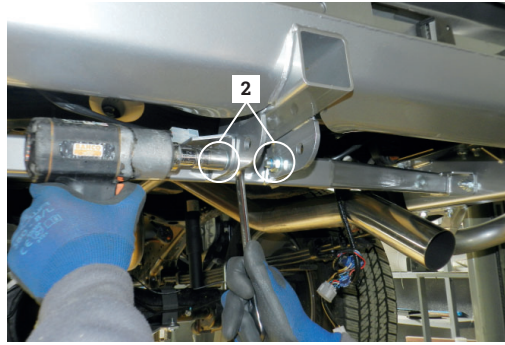

## Step 6

Once the **AFN Rear Bumper** is fitted, reattach the electrical wires for the Rear registration plate lamp.

*We advise to do a test in order to check if all the lights are correctly working.*

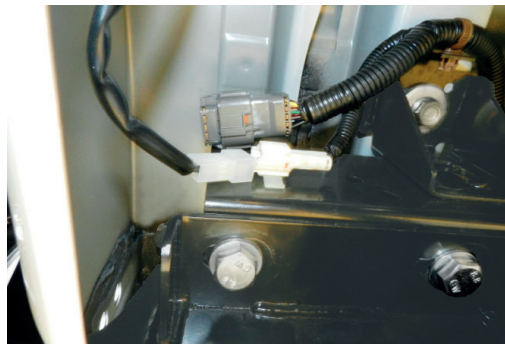

## Step 7

These two bolts are made for when you attach the towbar, you may adjust it the best way.

Bolts needed:

**1** - 45000267; 45000034; **M12x40**  
**2** - 45000267; 45000034; **M12x40**

*Since these two are optional, you can fully tight them.*

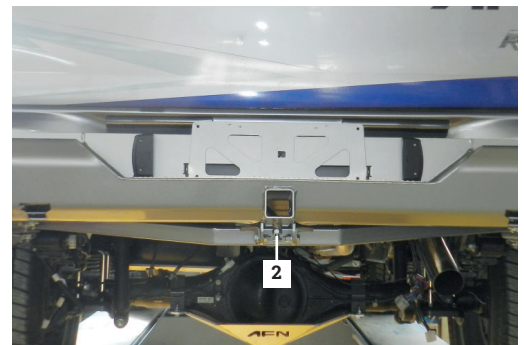

## Step 8

Your new **AFN REAR STEP BAR** is now installed on your **Toyota Hilux REVO!**

Have Fun!



## Reminder !

Before operating a vehicle fitted with an **AFN Rear Step**:

- Make sure all fittings are tightened
- Check all electrical wiring attached to lights and parking sensors (if installed)

## Maintenance | Care

Periodically check and tighten all nuts. Stripped, fractured or bent bolts or nuts need to be replaced.



## 3 D-MAX CATALOGUE

**AFN 4x4 Accessories** is becoming a well known brand for its products due to its quality, design and safety which are challenged for thousands of people everyday, worldwide.

In its diversity of products we can include, with all-terrain quality, protection, safety and aesthetic accessories. With that being said, **AFN 4x4** has some other accessories that every offroad passionate would like to have, such as **Body Protections, Underbody Protections, Light Holders, Storage** (Wheel Supports and Jerry-can carriers) and others related to the **Aesthetics**.

We have some 4x4 accessories that combine with the original model lines that if you take a closer look you will see that they don't appear to be an accessory, but a must-have.

Please be in mind that some accessories are available only to some models.

Feel free to check all the products that may interest you in our website at: [www.afn.pt](http://www.afn.pt)



Ref.: 48002470 - Front Bumper



Ref.: 48002295 - Bull Bar with fog lights



Ref.: 48002302 - Side Steps



Ref.: 48002304 - Rear Step Bar w/ trailer hitch



Ref.: 48002323 - Nerf Bars



Ref.: 48002296 - Rear Bumper w/ Wheel and Jerry-can carrier



Ref.: 48001690 - Steering Bars Aluminium Skid Plate



Ref.: 48002297 - Sump Guard Skid Plate (\*Al)



Ref.: 48002298 - Gearbox Axle Skid Plate (\*Al)



Ref.: 48002299 - Transfer Box Skid Plate (\*Al)



Ref.: 48002300 - Fuel Tank Skid Plate (\*Al)



Ref.: 48002301 - Rear Axle Skid Plate (\*Al)

\*Al - Aluminium

## 4 WARRANTY TERMS



**AFN4x4** products are warranted free from defects in materials and workmanship for a period of two (2) years from the date of initial retail purchase. Third-party components are delivered under the original manufacturer warranty.

Under the present warranty, **AFN4x4** obligation shall be limited to repairing, replacing or crediting, at its option, any part found to be defective.

**AFN4x4** does not warrant or make any representations concerning its goods when:

- a) The products are purchased used, scratch and dent or when the box was opened.
- b) The products are not installed, used, and maintained strictly in accordance with **AFN4x4**'s instructions.
- c) The products are installed in vehicles that are used in competition.
- d) The products are installed in vehicles fitted with aftermarket non-standard tires with diameters in excess of OEM\* specifications.
- e) The products are installed in vehicles with engines that have been modified to increase performance.

**AFN4x4** will not be responsible for goods damaged in transit. If any goods arrive damaged, please contact the **AFN4x4** as soon as possible. **AFN4x4** will assess and may arrange to have the damaged goods returned to a **AFN4x4** Distributor and arrange for a replacement of the goods. Damaged goods must be returned in the condition received by you with all original packaging, accessories and/or manuals. If they are not returned in same condition sent there may be an additional fee charged.

To file a claim under this warranty please contact **AFN4x4** at +351 256 808 300 or via email at [geral@afn.pt](mailto:geral@afn.pt) to request a *Returned Goods Authorization (RGA)* number and instructions for returning the defective component.

novο texto

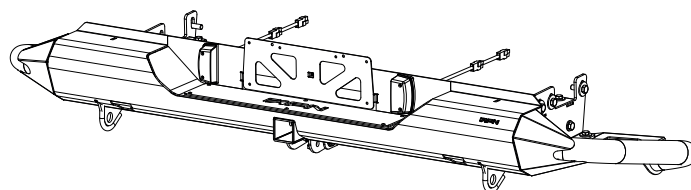

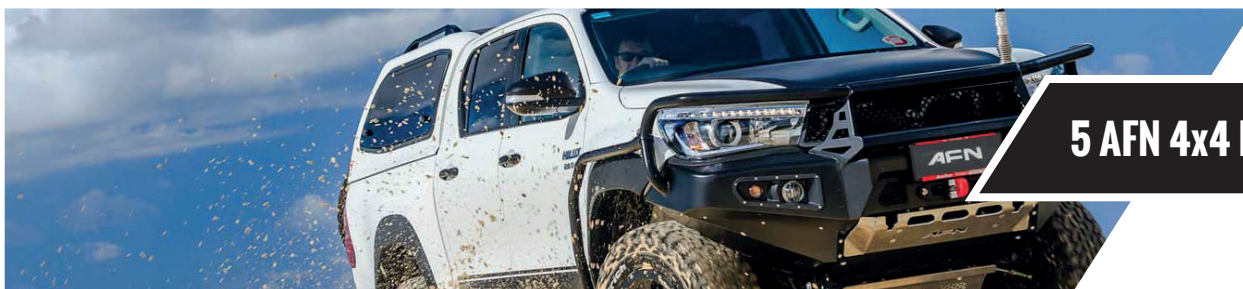

**5 AFN 4x4 PARTNERS**



**01**

**Portugal**

Rua da Madeira, 113  
Z. Industrial das Travessas  
3700-176 S. João da Madeira

T:(00351) 256 838 300/7  
geral@afn.com  
www.afn.com

**02**

**Espanha**

Carretera de Moledo 8  
pol. ind. de Miraflores, Nave 20  
36214, Vigo (Pontevedra)

T:(0034) 986 378338  
info@4x4misutonida.com  
www.4x4misutonida.com

**03**

**Austrália**

19 Flinders Parade  
North lakes  
QLD 4509

T:(0061) 1300 236 494  
sales@afn4x4.com.au  
www.afn4x4.com.au

**04**

**Costa Rica**

Fort overlanding CR,  
Alajuela

T:(0011) 506 8430 0211  
info@fortoverlanding.com  
www.fortoverlanding.com

DON'T JUST SETTLE FOR THE SAME OLD BULL



WWW.AFN.PT | SALES@AFN.PT | FACEBOOK.COM/AFN4X4

# WELCOME TO THE AFN FAMILY



PROGRAMA OPERACIONAL REGIONAL DO NORTE



União Europeia

Fundo Europeu de Desenvolvimento Regional



4 x 4 ACCESSORIES