

# CRAFTED LIKE NO OTHER

DON'T JUST SETTLE  
FOR THE SAME  
OLD BULL

**OWNER MANUAL**

TOYOTA  
HILUX REVO 2015+

**AFN**<sup>®</sup>  
4 X 4 ACCESSORIES

# WELCOME TO THE AFN FAMILY

This manual contains the Toyota HILUX REVO +2015 fitting instructions for:

Sump Guard Skid Plate Ref.: 48002297

Transfer Skid Plate Ref.: 48002299

Rear Axle Skid Plate Ref.: 48002301

Gearbox Skid Plate Ref.: 48002298

Fuel Tank Skid Plate Ref.: 48002300



# 1 INTRODUCTION

## The Company

Founded in 1995, AFN - 4x4 Accessories dedicates itself to the production and commerce of all-terrain accessories. Its constant concern in its customers total satisfaction, and in the ideals of innovation and transformation have granted a position of notability both in the national and international panorama.

The only company in Portugal in the mass production of 4x4 accessories, relies on specialized and experienced technicians, with the most adequate knowledge, to an efficient response capability to its customers demands.

Thanks to the specialization in the several areas of design and manufacture and to a constant investment in technology, AFN has been broadening its wide range of products, without ever neglecting the quality factor.

## 4x4 Accessories

In its diversity of products we can include, with all-terrain quality, protection, safety and aesthetic accessories.

And it is here that AFN invest on the best technology, the best cut precision of the raw material, and the transformation of products with the quality recognized in the marketplace.

AFN has, at its disposal, resources to test and analyse the resistance of its products and stands in the front row regarding the European homologation of materials dedicated to all terrain.

The contact with the most important test laboratories for vehicles, both in England, Spain and Germany, provides AFN with the know-how to manufacture a wide range of quality products.

## Our Design Approach

AFN designs each accessory taking into consideration the original model lines and fixing points. We refuse to have a "one design fits all" solution and we are always looking forward to embrace new challenges on how to adjust a new product into a new model!

The days of just throwing on a bit of steel together to form a protection system are gone. AFN is leading the way modern vehicle protection components are manufactured. Other will follow, and it won't be long where the AFN approach to Styling, Fit, Form and Function will become the benchmark for all other manufacturers.







**INDEX**



**AFN 4x4 Accessories**

Product: **Sump Guard Skid Plate**  
Part Ref.: **48002297**

Product: **Gearbox Skid Plate**  
Part Ref.: **48002298**

Product: **Transferbox Skid Plate**  
Part Ref.: **48002299**

Product: **Fuel Tank Skid Plate**  
Part Ref.: **48002300**

Product: **Rear Axle Skid Plate**  
Part Ref.: **48002301**

Introduction 2

1 Checklist 4

Products 48002297, 48002298, 48002299, 48002300, 48002301

2 Fitting Instructions 7

3 Hilux REVO Catalogue 13

4 Warranty Terms 14

5 AFN 4x4 Partners 15



# 1 CHECKLIST



- In this section you have a checklist with all parts included for the installation of your AFN product
- This product should be installed as demonstrated in the product fitting instructions
- If verified that any component is damaged, please contact your nearest AFN distributor
- The specified parts will only fit in the models specified by AFN
- Do not modify any component of the product

Please note that the following checklists are **divided by each Underbody Protection reference**. With that in mind, if you are using the **full Underbody Protections**, there are **some part numbers that will be duplicated, just put them aside**.

## 48002297 - Sump Guard Skid Plate



Ref.: 46006475  X1



Ref.: 46006474  X1



Ref.: 46006409  X1



**Zinc Plated**  
Ref.: 45000074  X4  
M6



**Zinc Plated**  
Ref.: 45000044  X8  
M8

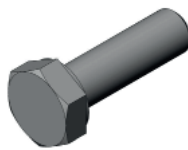

**Zinc Plated**  
Ref.: 45000043  X4  
M6x20



**Zinc Plated**  
Ref.: 45000011  X6  
M8

## 48002298 - Gearbox Skid Plate

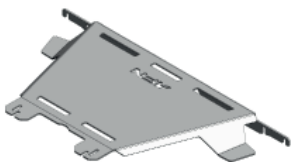

Ref.: 46006412  X1



**Zinc Plated**  
Ref.: 45000312  X4  
M12x130x40

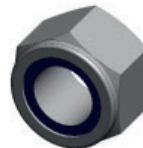

**Zinc Plated**  
Ref.: 45000066  X4  
M12



**Zinc Plated**  
Ref.: 45000036  X8  
M12



### 48002298 - Gearbox Skid Plate



Zinc Plated  
Ref.: 45000011  
M8

X2

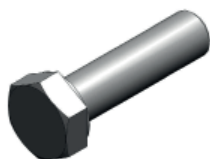

Zinc Plated  
Ref.: 45000008  
M8x30

X2

### 48002299 - Transferbox Skid Plate



Ref.: 47001717

X1



Ref.: 46006416

X2



Ref.: 46006414

X2

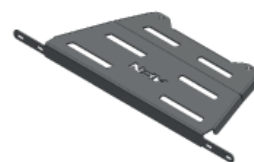

Ref.: 46006413

X1



Zinc Plated  
Ref.: 45000312  
M12x130x40

X4

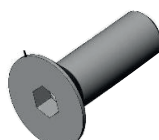

Zinc Plated  
Ref.: 45000110  
M10x25

X2



Zinc Plated  
Ref.: 45000069  
M10x35

X4

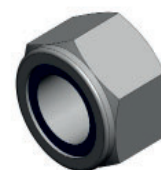

Zinc Plated  
Ref.: 45000066  
M12

X4



Zinc Plated  
Ref.: 45000036  
M12

X8

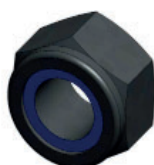

Zinc Plated  
Ref.: 45000017  
M10

X6



Zinc Plated  
Ref.: 45000010  
M10

X10

### 48002300 - Fuel Tank Skid Plate



Ref.: 46006417

X1



Ref.: 45000011

X5



**48002301 - Rear Axle Skid Plate**



Ref.: 47001855  X1



Ref.: 45001721  X1



Ref.: 46007003  X1



Zinc Plated  
Ref.: 46006476  X1



Ref.: 46006421  X1



Ref.: 46006419  X2

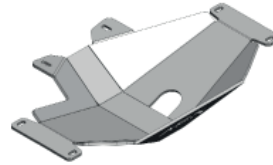

Ref.: 46006418  X1



Zinc Plated  
Ref.: 45000120  
M8x15  X1

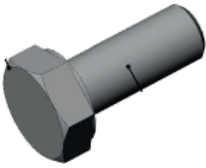

Zinc Plated  
Ref.: 45000113  
M6x15  X1



Zinc Plated  
Ref.: 45000044  
M6  X1

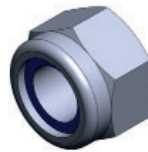

Zinc Plated  
Ref.: 45000018  
M8  X6



Zinc Plated  
Ref.: 45000011  
M8  X13



Zinc Plated  
Ref.: 45000008  
M8x30  X6

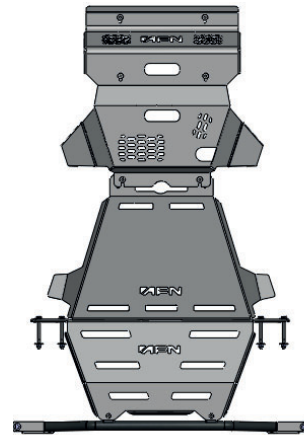





## 2 FITTING INSTRUCTIONS

### WARNING:

Before you begin installation, read all instructions thoroughly.  
Proper tools will improve the quality of installation and reduce the time required.

- This product should be installed as demonstrated in the *Product «Fitting Instructions»*;
- The specified parts, will only fit the models specified by **AFN**;
- Do not modify any component of the product;
- It is recommended that this product is installed by specialized and trained personnel;
- AFN doesn't take responsibility for changes made in the vehicle by its manufacturer;
- Work safely and use specialized tools at all times;
- **Always use protective gear.**



| Size | Torque Nm | Torque lbft |
|------|-----------|-------------|
| M6   | 9 Nm      | 7 lbft      |
| M8   | 22 Nm     | 16 lbft     |
| M10  | 44 Nm     | 32 lbft     |
| M12  | 77 Nm     | 57 lbft     |

### Mouting Time

- 2 hours (All underbody protections)
- 1 person (recommended)

### Tools Required

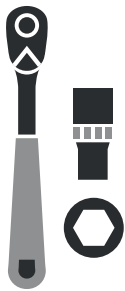

- Wrench
- Ratchet wrench
- Allen wrench
- Lift



## Step 1

Before fitting the **Front Skid Plate - 48002297**, place it on a working surface and fit **46006474**.

Bolts needed:  
**1** - 45000043; 45000044 **x2**;  
45000074; **M6x20**

Repeat this step on the other side for part number **46006475**.

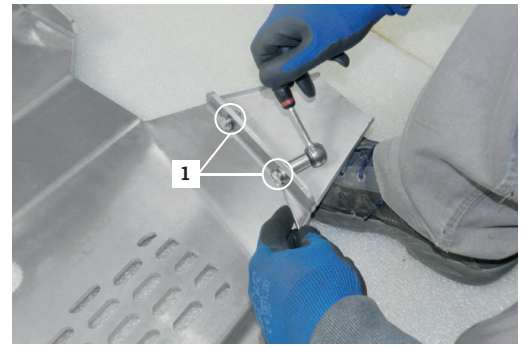
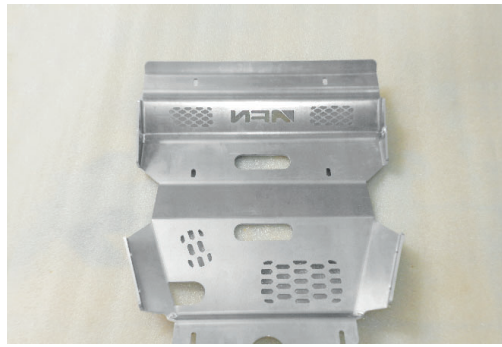

### Give the final torque.

It must look like as showed in the image on the right.

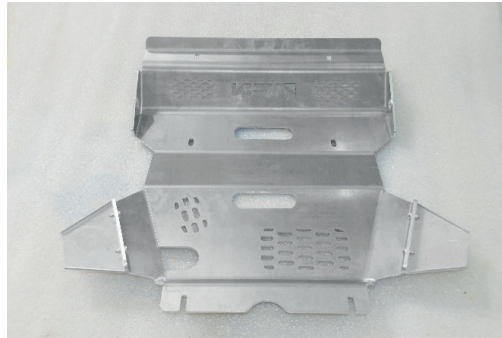

## Step 2

Fit the **Front Skid Plate - 48002297** on the vehicle chassis.

Bolts needed:  
**1** - OEM\* bolts; 45000011; **M8**  
**2** - OEM\* bolts; 45000011; **M8**

### Give the final torque.

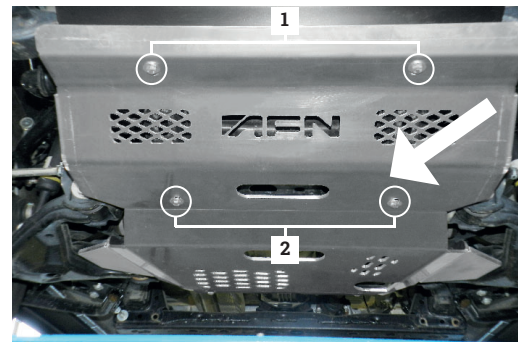

## Step 3

Fit the bottom of the **Front Skid Plate - 48002297** to the chassis.

Bolts needed:  
**1** - OEM\* bolts; 45000011; **M8**

**Be in mind that if you have more underbody protections to be fitted, do NOT FULL TIGHT.**

### Give the final torque.





## Step 4

Fit the **Gearbox Skid Plate - 48002298** in the chassis.

This one must be fitted **above** the **Transferbox Skid Plate - 48002297**. Bolts needed:  
**1** - OEM\* bolts; 45000011; **M8**  
**2** - 45000008; 45000011; **M8**

*Tip* you may use a jack to hold the protection in place.

**Give the final torque.**

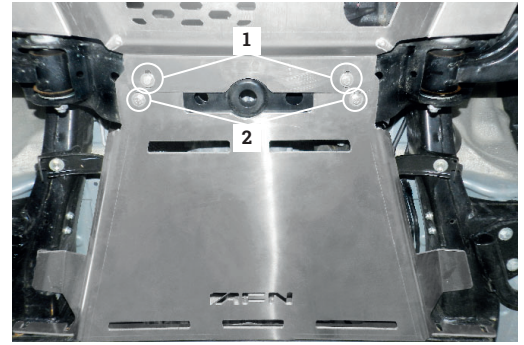
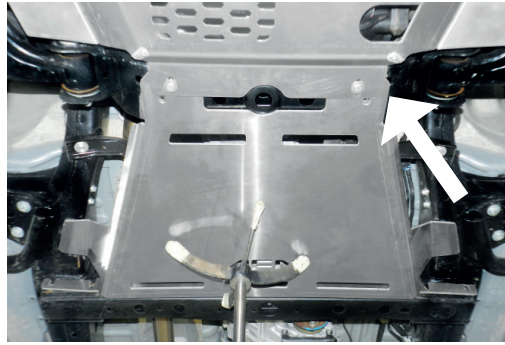

## Step 5

Fit the bottom of the **Gearbox Skid Plate - 48002298** in the chassis.

Bolts needed:  
**1** - 45000312; 45000036 x2;  
 45000066; **M12x130x40**

Repeat this step on the other side of the **Gearbox Skid Plate**.

**Give the final torque.**

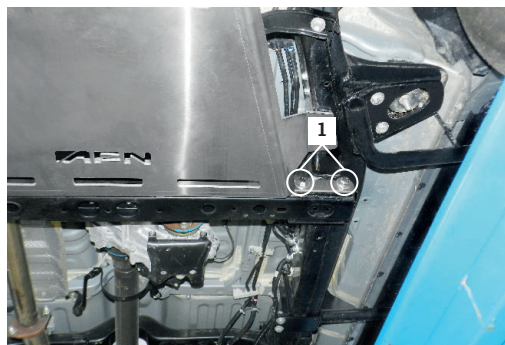

## Step 6

Fit part number **47001717** on the vehicle chassis.

Then, fit part number **46006416**. It must enter from the outer side of vehicle.

Parts needed:  
**1** - 46006416;  
**2** - 45000069; 45000010 x2;  
 45000017; **M10x35**

Repeat this step on the other side of part number **46006416**.

**Give the final torque.**

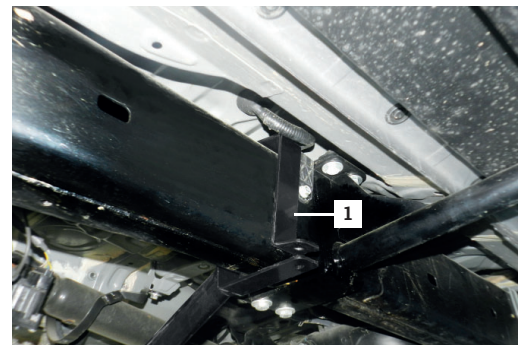

Be in mind that there are some cables in this area, so be careful they don't be crushed.



## Step 7

Fit the **Transferbox Skid Plate - 48002299** in the chassis. This one must be fitted as showed in the image on the right.

If you have the **Gearbox Skid Plate - 48002298** mounted on the vehicle, use its bolts and nuts (see #step5)

Parts needed:

- 1 - 46006414;
- 2 - 45000312; 45000036 x2; 45000066; **M12x130x40**
- 3 - 45000110; 45000010; 45000017; **M10x25**

**Give the final torque.**

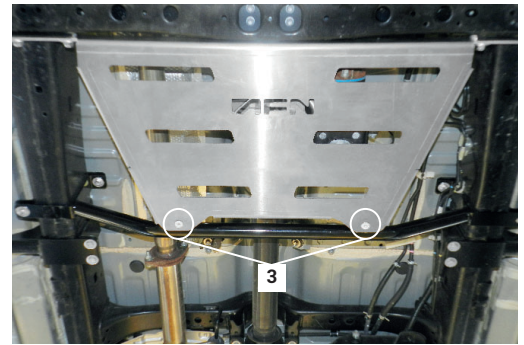
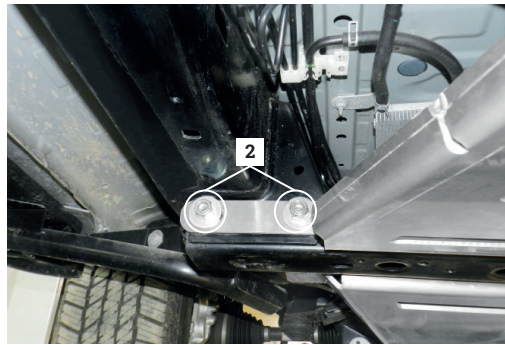
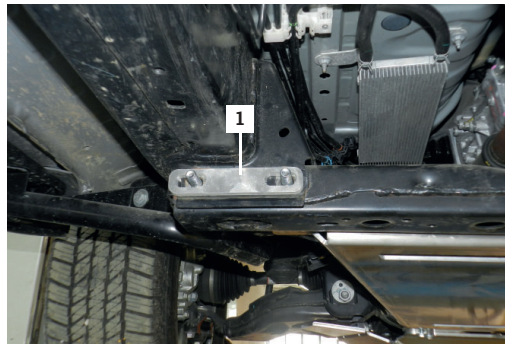

## Step 8

Remove the OEM\* **Fuel Tank Protection** as showed in the image.

Be aware that you must save the OEM\* Nuts, you'll use them later in the **AFN Fuel Tank Skid Plate - 48002300**.

- 1 - OEM\* Nut;

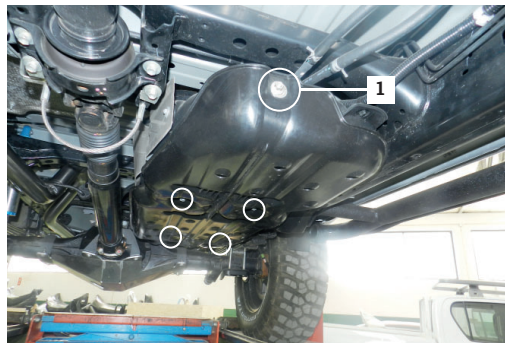

## Step 9

Fit the **Fuel Tank Skid Plate - 48002300** as showed in the image.

It must be fitted first on the side, then in the bottom.

Bolts needed:

- 1 - 45000011; OEM\* Nut; **M8**

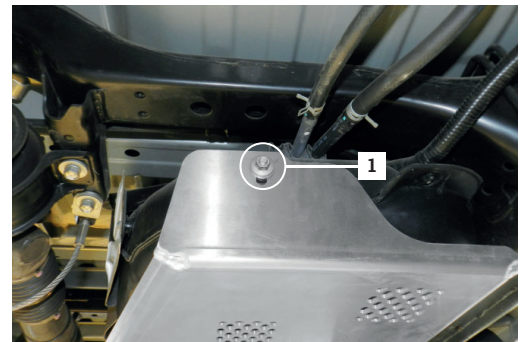



## Step 9

Once the **Fuel Tank Skid Plate - 48002300** is in place, fit the other **4 OEM\*** nuts, as showed in the image on the right.

Bolts needed:  
**1 - 45000011; M8**

**Give the final torque.**

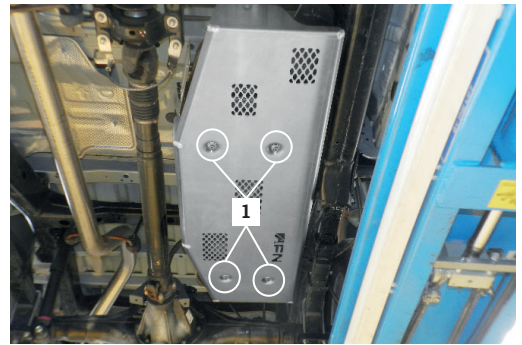
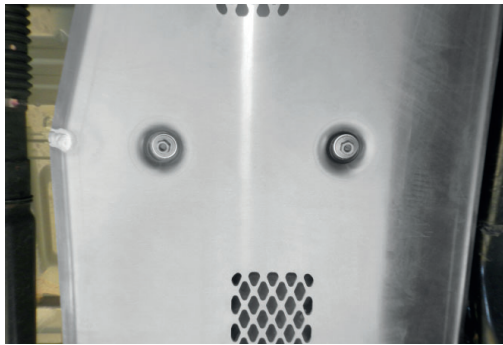

## Step 10

The following step may vary depending on which version of vehicle you have, so be aware that:

**- European Version:**

Join **47001855** with **46007003**.

**- Tropicalized Version:**

Join **47001721** with **46006421**.

Before fitting the **Rear Axle Skid Plate - 48002301** in the chassis, take on part number **47001721/47001855** and fit it to part number **46006421/46007003**.

Parts needed:

**1 - 46006421 / 46007003;**  
**2 - 45000113; 45000044; M6x15**  
**3 - 47001721 / 47001855;**  
**4 - 46006476;**  
**5 - 45000120; 45000011; M8x15**

**Give the final torque.**

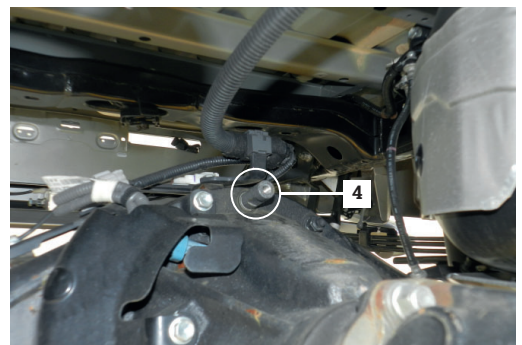
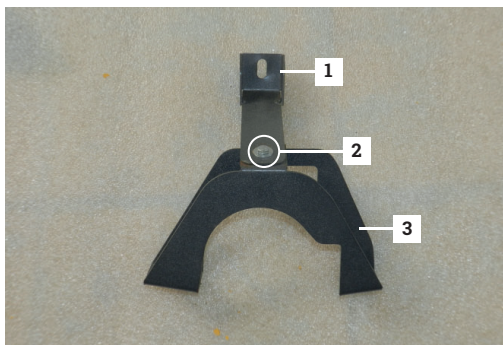

## Step 11

Put the **Rear Axle Brackets - 46006419**, one on each side as showed in the image.

Fit the **Rear Axle Skid Plate - 48002301** in the Rear Axle Brackets - **46006419**.

Bolts needed:  
**1 - 45000008; 45000011 x2; M8x30**

Repeat this step on the other side.

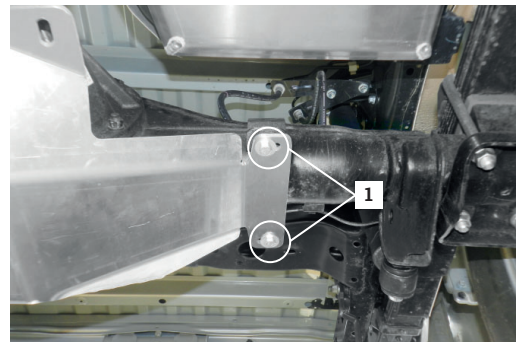

## Step 12

Fit the **Rear Axle Skid Plate - 48002301** to the **47001721 / 47001855**.

Bolts needed:  
**1** - 45000008; 45000011 **x2**;  
48000018; **M8x30**

**Give the final torque.**

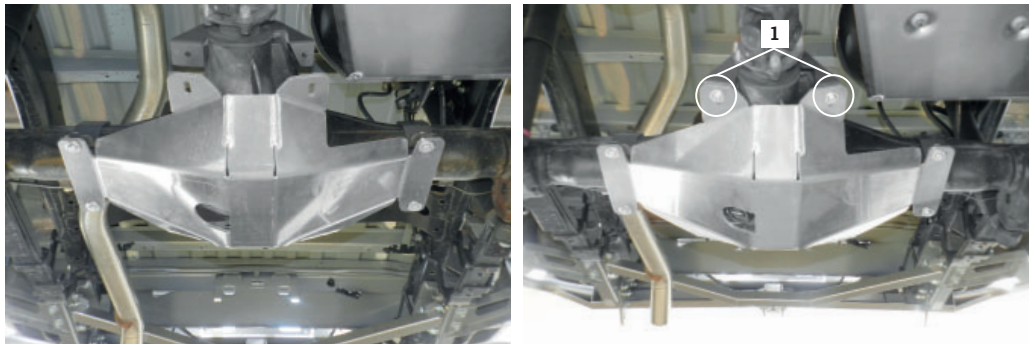

## Step 13

Your new **AFN UNDERBODY PROTECTIONS** are now installed on your **Toyota Hilux REVO!**

Have Fun!



## Reminder !

Before operating a vehicle fitted with an AFN Underbody Protections:  
- Make sure all fittings are tightened

## Maintenance | Care

Periodically check and tighten all nuts. Stripped, fractured or bent bolts or nuts need to be replaced.



### 3 Hilux REVO CATALOGUE

**AFN 4x4 Accessories** is becoming a well known brand for its products due to its quality, design and safety which are challenged for thousands of people everyday, worldwide.

In its diversity of products we can include, with all-terrain quality, protection, safety and aesthetic accessories. With that being said, **AFN 4x4** has some other accessories that every offroad passionate would like to have, such as **Body Protections, Underbody Protections, Light Holders, Storage** (Wheel Supports and Jerry-can carriers) and others related to the **Aesthetics**.

We have some 4x4 accessories that combine with the original model lines that if you take a closer look you will see that they don't appear to be an accessory, but a must-have.

Please be in mind that some accessories are available only to some models.  
 Feel free to check all the products that may interest you in our website at: [www.afn.pt](http://www.afn.pt)



Ref.: 48002470 - Front Bumper



Ref.: 48002295 - Bull Bar with fog lights



Ref.: 48002302 - Side Steps



Ref.: 48002304 - Rear Step Bar w/ trailer hitch



Ref.: 48002323 - Nerf Bars



Ref.: 48002296 - Rear Bumper w/ Wheel and Jerry-can carrier

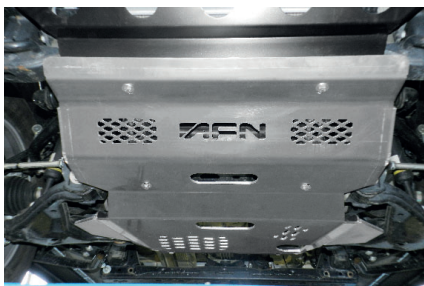

Ref.: 48002297 - Sump Guard Skid Plate (\*Al)



Ref.: 48002298 - Gearbox Axle Skid Plate (\*Al)

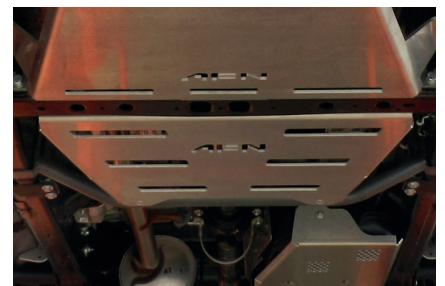

Ref.: 48002299 - Transfer Box Skid Plate (\*Al)



Ref.: 48002300 - Fuel Tank Skid Plate (\*Al)



Ref.: 48002301 - Rear Axle Skid Plate (\*Al)

\*Al - Aluminium

## 4 WARRANTY TERMS



**AFN4x4** products are warranted free from defects in materials and workmanship for a period of two (2) years from the date of initial retail purchase. Third-party components are delivered under the original manufacturer warranty.

Under the present warranty, **AFN4x4** obligation shall be limited to repairing, replacing or crediting, at its option, any part found to be defective.

**AFN4x4** does not warrant or make any representations concerning its goods when:

- a) The products are purchased used, scratch and dent or when the box was opened.
- b) The products are not installed, used, and maintained strictly in accordance with **AFN4x4**'s instructions.
- c) The products are installed in vehicles that are used in competition.
- d) The products are installed in vehicles fitted with aftermarket non-standard tires with diameters in excess of *OEM\** specifications.
- e) The products are installed in vehicles with engines that have been modified to increase performance.

**AFN4x4** will not be responsible for goods damaged in transit. If any goods arrive damaged, please contact the **AFN4x4** as soon as possible. **AFN4x4** will assess and may arrange to have the damaged goods returned to a **AFN4x4** Distributor and arrange for a replacement of the goods. Damaged goods must be returned in the condition received by you with all original packaging, accessories and/or manuals. If they are not returned in same condition sent there may be an additional fee charged.

To file a claim under this warranty please contact **AFN4x4** at +351 256 808 300 or via email at [geral@afn.pt](mailto:geral@afn.pt) to request a *Returned Goods Authorization (RGA)* number and instructions for returning the defective component.

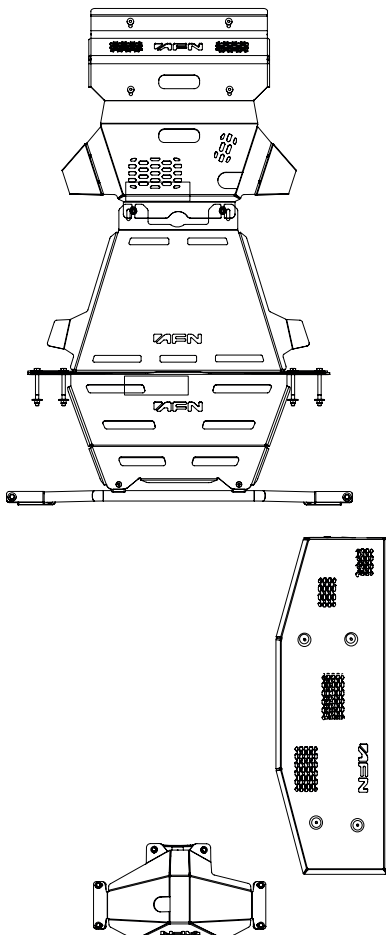

\*OEM - Original Equipment Manufacturer





**5 AFN 4x4 PARTNERS**



**01**

**Portugal**

Rua da Madeira, 113  
Z. Industrial das Travessas  
3700-176 S. João da Madeira

T:(00351) 256 838 300/7  
geral@afn.com  
www.afn.com

**02**

**Espanha**

Carretera de Moledo 8  
pol. ind. de Miraflores, Nave 20  
36214, Vigo (Pontevedra)

T:(0034) 986 378338  
info@4x4misutonida.com  
www.4x4misutonida.com

**03**

**Austrália**

19 Flinders Parade  
North lakes  
QLD 4509

T:(0061) 1300 236 494  
sales@afn4x4.com.au  
www.afn4x4.com.au

**04**

**Costa Rica**

Fort overlanding CR,  
Alajuela

T:(0011) 506 8430 0211  
info@fortoverlanding.com  
www.fortoverlanding.com



DON'T JUST SETTLE FOR THE SAME OLD BULL



WWW.AFN.PT | @AFN\_PT | FACEBOOK.COM/AFN\_PT

# WELCOME TO THE AFN FAMILY



União Europeia  
Fundo Europeu de  
Desenvolvimento Regional

