

CRAFTED LIKE NO OTHER

DON'T JUST SETTLE
FOR THE SAME
OLD BULL

OWNER MANUAL

TOYOTA
PRADO 150 2018+

AFN[®]
4 X 4 ACCESSORIES



WELCOME TO THE AFN FAMILY

This manual contains the **Toyota PRADO 150 +2018** fitting instructions for:

Front Skid Plate Ref.: 48001451

Gearbox Skid Plate Ref.: 48001917

Sump Guard Skid Plate Ref.: 48001462

Transferbox Skid Plate Ref.: 48001918

1 INTRODUCTION



The Company

Founded in 1995, AFN - 4x4 Accessories dedicates itself to the production and commerce of all-terrain accessories. Its constant concern in its customers total satisfaction, and in the ideals of innovation and transformation have granted a position of notability both in the national and international panorama.

The only company in Portugal in the mass production of 4x4 accessories, relies on specialized and experienced technicians, with the most adequate knowledge, to an efficient response capability to its customers demands.

Thanks to the specialization in the several areas of design and manufacture and to a constant investment in technology, AFN has been broadening its wide range of products, without ever neglecting the quality factor.

4x4 Accessories

In its diversity of products we can include, with all-terrain quality, protection, safety and aesthetic accessories.

And it is here that AFN invest on the best technology, the best cut precision of the raw material, and the transformation of products with the quality recognized in the marketplace.

AFN has, at its disposal, resources to test and analyse the resistance of its products and stands in the front row regarding the European homologation of materials dedicated to all terrain.

The contact with the most important test laboratories for vehicles, both in England, Spain and Germany, provides AFN with the know-how to manufacture a wide range of quality products.

Our Design Approach

AFN designs each accessorie taking into consideration the original model lines and fixing points. We refuse to have a "one design fits all" solution and we are always looking foward to embrace new challenges on how to adjust a new product into a new model!

The days of just throwing on a bit of steel together to form a protection system are gone. AFN is leading the way modern vehicle protection components are manufactured. Other will follow, and it won't be long where the AFN approach to Styling, Fit, Form and Function will become the benchmark for all other manufacturers.





INDEX



AFN 4x4 Accessories

Product: **Front Skid Plate**
Part Ref.: **48001451**

Product: **Sump Guard Skid Plate**
Part Ref.: **48001462**

Product: **Gearbox Skid Plate**
Part Ref.: **48001917**

Product: **Transferbox Skid Plate**
Part Ref.: **48001918**

Introduction 2

1 Checklist 4
Products 48001451, 48001462, 48001917, 48001918

2 Fitting Instructions 7

3 D-MAX Catalogue 11

4 Warranty Terms 12

5 AFN 4x4 Partners 13



1 CHECKLIST



- In this section you have a checklist with all parts included for the installation of your AFN product
- This product should be installed as demonstrated in the product fitting instructions
- If verified that any component is damaged, please contact your nearest AFN distributor
- The specified parts will only fit in the models specified by AFN
- Do not modify any component of the product

Please note that the following checklists are **divided by each Underbody Protection reference**. With that in mind, if you are using the **full Underbody Protections**, there are **some part numbers that will be duplicated, just put them aside**.

48001451 - Front Skid Plate

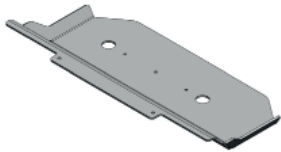

Ref.: 46003253 X1



Ref.: 46003254 X1



Zinc Plated
Ref.: 45000083
M8x35

X2

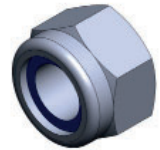

Zinc Plated
Ref.: 45000018
M8

X3



Zinc Plated
Ref.: 45000011
M8

X5



Zinc Plated
Ref.: 45000009
M8x25

X5

48001462 - Sump Guard Skid Plate



Ref.: 46003255 X1

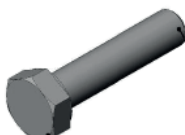

Zinc Plated
Ref.: 45000083
M8x35

X2



Zinc Plated
Ref.: 45000048
M8

X2



Zinc Plated
Ref.: 45000011
M8

X2

48001462 - Gearbox Skid Plate (Continuation)

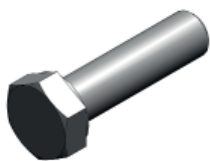

Zinc Plated

Ref.: 45000008
M8x30

X2

48001917 - Gearbox Skid Plate



Ref.: 46004726

X1

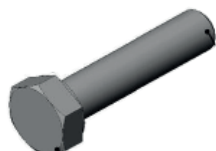

Zinc Plated

Ref.: 45000091
M8x40

X4



Zinc Plated

Ref.: 45000039
M10

X4

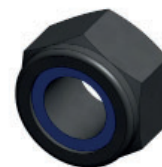

Zinc Plated

Ref.: 45000017
M10

X2



Zinc Plated

Ref.: 45000011
M8

X4

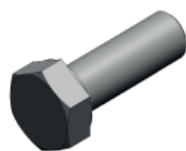

Zinc Plated

Ref.: 45000007
M10x30

X2

48001918 - Transferbox Skid Plate



Ref.: 46004726

X1



Ref.: 47001092

X1



Ref.: 47001091

X1

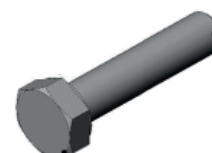

Zinc Plated

Ref.: 45000091
M8x40

X4

48001918 - Transferbox Skid Plate (Continuation)



Zinc Plated

Ref.: 45000069
M10x35

X2



Zinc Plated

Ref.: 45000048
M8

X4



Zinc Plated

Ref.: 45000010
M10

X2





2 FITTING INSTRUCTIONS

WARNING:

Before you begin installation, read all instructions thoroughly.
Proper tools will improve the quality of installation and reduce the time required.

- This product should be installed as demonstrated in the *Product «Fitting Instructions»*;
- The specified parts, will only fit the models specified by **AFN**;
- Do not modify any component of the product;
- It is recommended that this product is installed by specialized and trained personnel;
- AFN doesn't take responsibility for changes made in the vehicle by its manufacturer;
- Work safely and use specialized tools at all times;
- **Always use protective gear.**



Size	Torque Nm	Torque lbft
M6	9 Nm	7 lbft
M8	22 Nm	16 lbft
M10	44 Nm	32 lbft
M12	77 Nm	57 lbft

Mouting Time

- 2 hours (**All underbody protections**)
- 1 person (recommended)

Tools Required

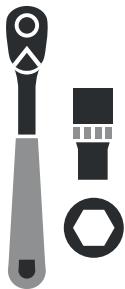

- Wrench
- Ratchet wrench
- Allen wrench
- Lift

Step 1 (Optional)

This step only applies if the vehicle is equipped with an **AFN Bullbar** or **AFN Bumper**. If Not, proceed to **Step 2**.

Lift the vehicle.
(we do recommend to use a lift)

Remove the front protection of the **AFN Bullbar** or **AFN Bumper**, as shown in the image.



Be aware that you must save the bolts and nuts, you'll use them on **step 3**.



Step 2

Start by fitting the **Front Skid Plate - 48001451**.

Take on part number **46003253** and fit the part number **46003254**.

Parts needed:

1 - 46003254; **M8**

2 - 45000009; 45000011;

45000018; **M8x25**

Give the final torque.

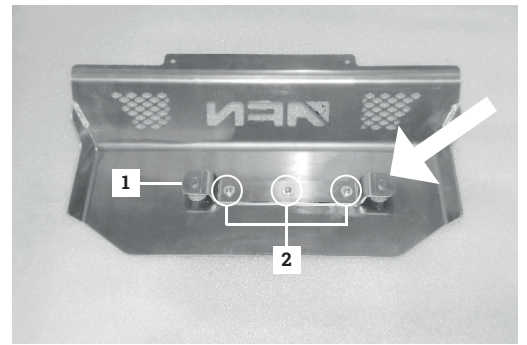
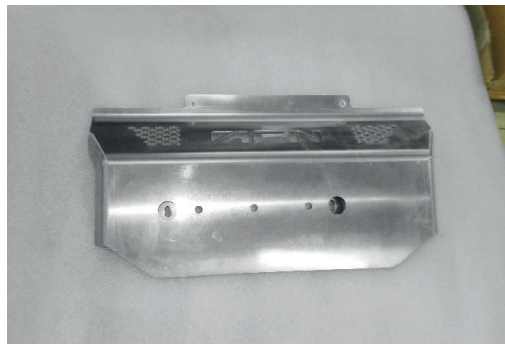

Step 3

Take on part number **46005986** and fit it to the chassis.

Bolts needed:

1 - 45000009; **M8x25**

This one must be fitted **above** the lower underbody armour part number **46006436***.

Give the final torque.

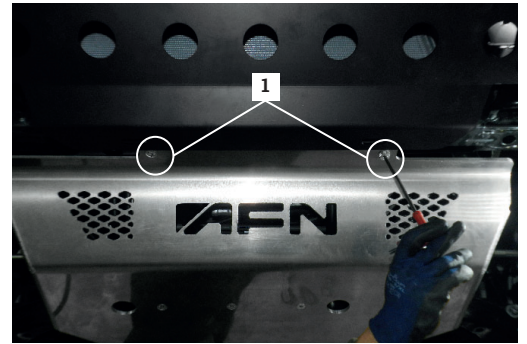
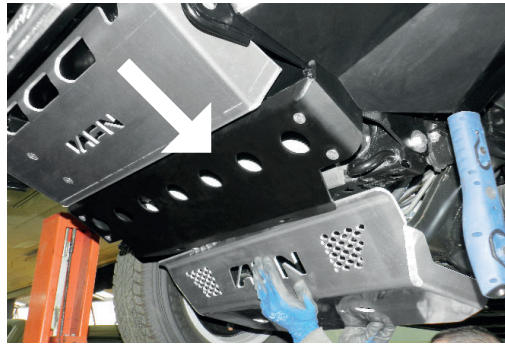

Step 4

Be in mind that if you have more underbody protections to be fitted, please skip this step.

Fit the **Gearbox Skid Plate - 48002209** in the chassis.

Bolts needed:

1 - 45000083; 45000011; **M10**

Give the final torque.

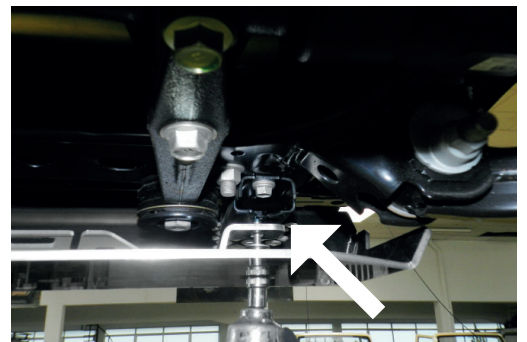
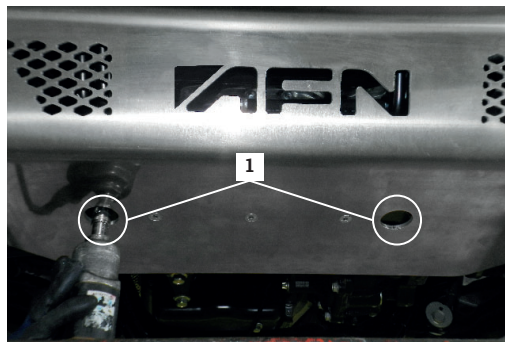

*46006436 - This part number goes in checklist for the **AFN Bullbar - 48002477**.

Step 5

Fit the **Gearbox Skid Plate - 48001462** in the chassis.

This one must be fitted **above** the **Transferbox Skid Plate - 48001451**. Parts needed:
1 - 46004726;
2 - 45000083; 45000011; **M10**
3 - 45000007; 45000035 x2;
 45000017; **M10x30**

Give the final torque.

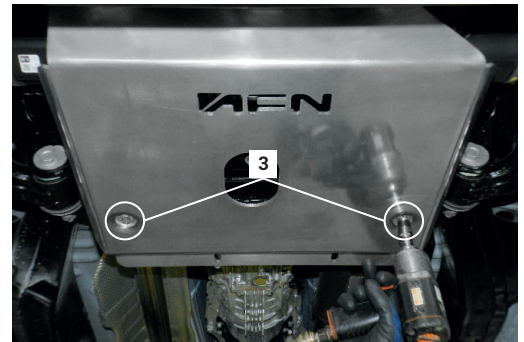
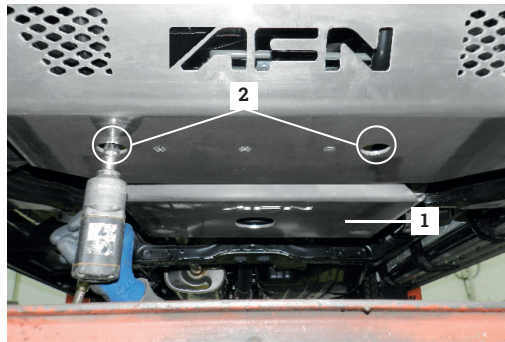

Step 6

Fit the **Gearbox Skid Plate - 48001917** in the chassis.

Before fitting this part, there are two **OEM*** Reinforcements that need to be removed.

Bolts needed:
1 - **OEM*** Bolts;

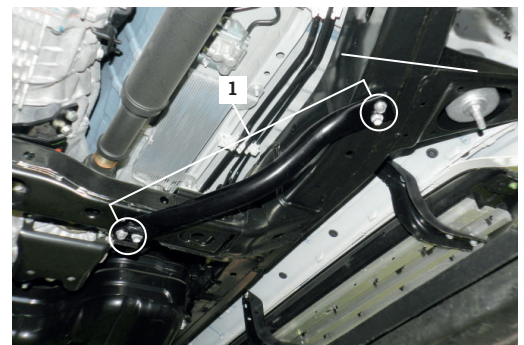
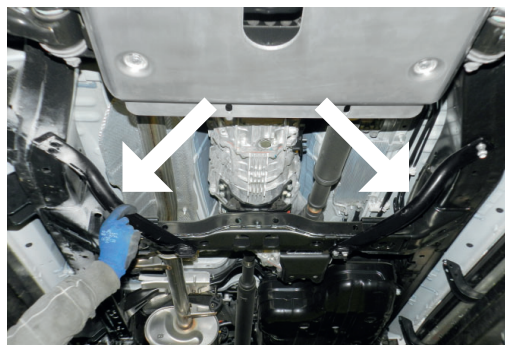

Step 7

Fit the **Front Skid Plate - 48002205** in the chassis.

This one must be fitted **above** the **Sump Guard Skid Plate - 48002207**.

Parts needed:
1 - 46004726;
2 - 45000091; 45000011; **M10x35**

Give the final torque.

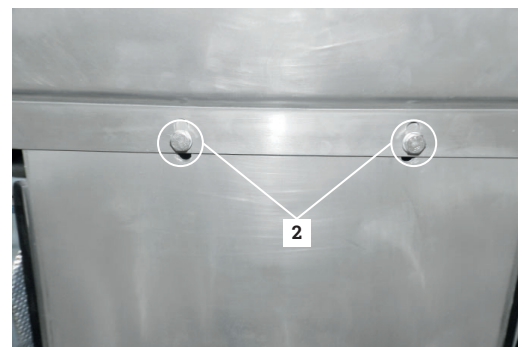
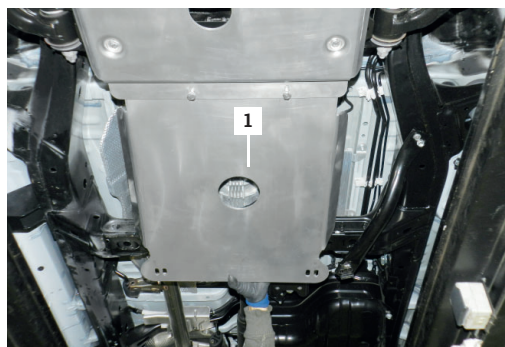

Step 8

Be in mind that if you have more underbody protections to be fitted, please skip this step.

The two **OEM*** Reinforcements must be fitted under **Skid Plate**

Bolts needed:
3 - Re-use **OEM*** Bolts;

Give the final torque.

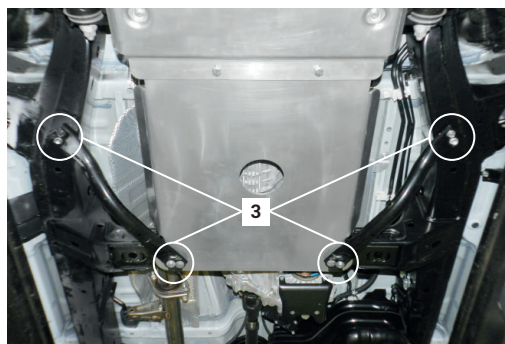

*OEM - Original Equipment Manufacturer

Step 9

Fit the **Transferbox Skid Plate - 48001918** in the chassis.

This one must be fitted **above** the **Gearbox Skid Plate - 48001917**. Parts needed:

1 - 46004727;

The two **OEM*** Reinforcements must be fitted under **Gearbox Skid Plate - 48001917**.

Bolts needed:

3 - Re-use **OEM*** Bolts;

Give the final torque.

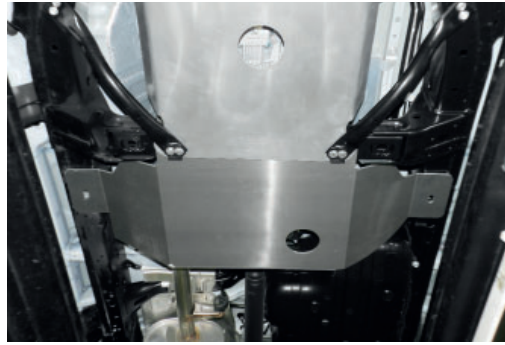

Step 10

Fit part number **47001091** on the left side of the chassis, connecting the vehicle to the **Transferbox Skid Plate - 48001918** as showed in the image.

Bolts needed:

1 - 47001091;

2 - 45000069; 45000010; M10x30

Repeat this step on the other side for part number **47001092**.

Give the final torque.

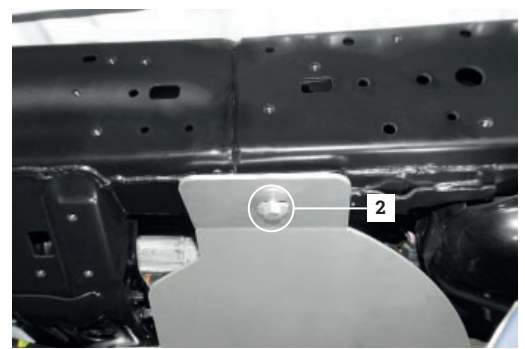
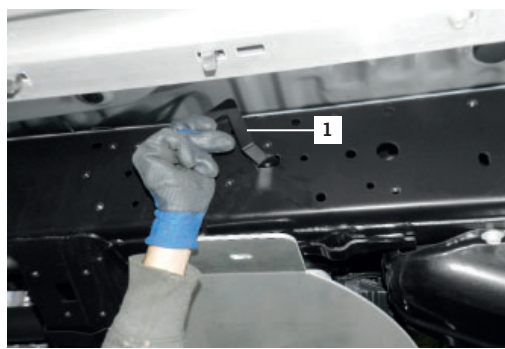

Step 11

Your new **AFN UNDERBODY PROTECTIONS** are now installed on your **Isuzu D-MAX!**

Have Fun!



Reminder!

Before operating a vehicle fitted with an AFN Underbody Protections:

- Make sure all fittings are tightened

Maintenance | Care

Periodically check and tighten all nuts. Stripped, fractured or bent bolts or nuts need to be replaced.



3 PRADO 150 CATALOGUE

AFN 4x4 Accessories is becoming a well known brand for its products due to its quality, design and safety which are challenged for thousands of people everyday, worldwide.

In its diversity of products we can include, with all-terrain quality, protection, safety and aesthetic accessories. With that being said, **AFN 4x4** has some other accessories that every offroad passionate would like to have, such as **Body Protections, Underbody Protections, Light Holders, Storage** (Wheel Supports and Jerry-can carriers) and others related to the **Aesthetics**.

We have some 4x4 accessories that combine with the original model lines that if you take a closer look you will see that they don't appear to be an accessorie, but a must-have.

Please be in mind that some accessories are available only to some models.

Feel free to check all the products that may interest you in our website at: www.afn.pt



Ref.: 48002XXX - Front Bumper



Ref.: 48002295 - Bull Bar with fog lights



Ref.: 48002478 - Side Steps



Ref.: 48002479 - Nerf Bars

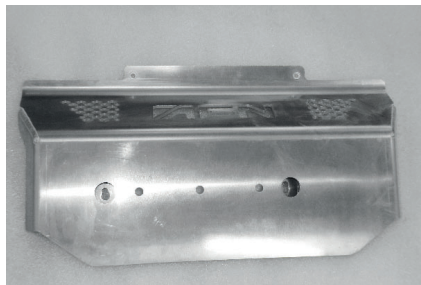

Ref.: 48001451 - Front Skid Plate (*Al)



Ref.: 48001462 - Sump Guard Skid Plate (*Al)



Ref.: 48001917 - Gearbox Skid Plate (*Al)

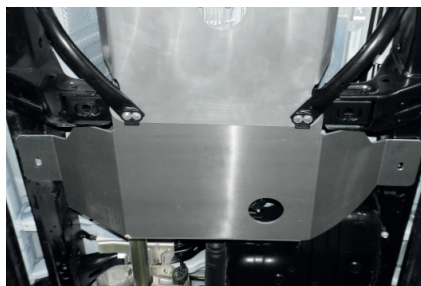

Ref.: 48001918 - Transferbox Skid Plate (*Al)

4 WARRANTY TERMS



AFN4x4 products are warranted free from defects in materials and workmanship for a period of two (2) years from the date of initial retail purchase. Third-party components are delivered under the original manufacturer warranty.

Under the present warranty, **AFN4x4** obligation shall be limited to repairing, replacing or crediting, at its option, any part found to be defective.

AFN4x4 does not warrant or make any representations concerning its goods when:

- a) The products are purchased used, scratch and dent or when the box was opened.
- b) The products are not installed, used, and maintained strictly in accordance with **AFN4x4**'s instructions.
- c) The products are installed in vehicles that are used in competition.
- d) The products are installed in vehicles fitted with aftermarket non-standard tires with diameters in excess of *OEM** specifications.
- e) The products are installed in vehicles with engines that have been modified to increase performance.

AFN4x4 will not be responsible for goods damaged in transit. If any goods arrive damaged, please contact the **AFN4x4** as soon as possible. **AFN4x4** will assess and may arrange to have the damaged goods returned to a **AFN4x4** Distributor and arrange for a replacement of the goods. Damaged goods must be returned in the condition received by you with all original packaging, accessories and/or manuals. If they are not returned in same condition sent there may be an additional fee charged.

To file a claim under this warranty please contact **AFN4x4** at +351 256 808 300 or via email at geral@afn.pt to request a *Returned Goods Authorization (RGA)* number and instructions for returning the defective component.

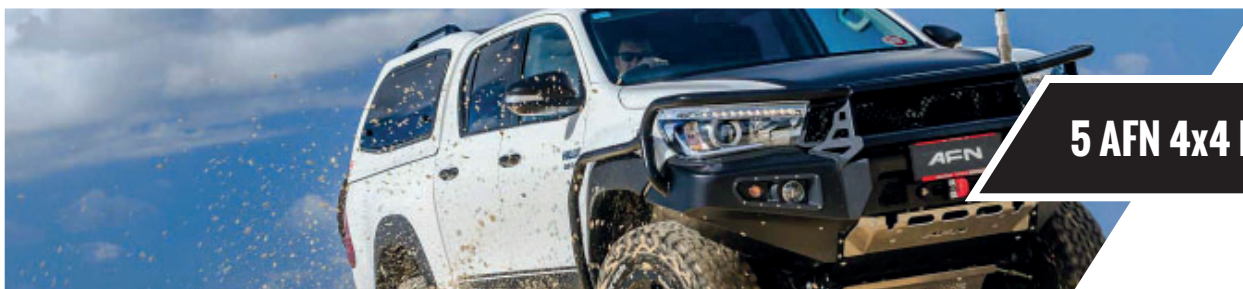

5 AFN 4x4 PARTNERS



01

Portugal

Rua da Madeira, 113
Z. Industrial das Travessas
3700-176 S. João da Madeira

T:(00351) 256 838 300/7
geral@afn.com
www.afn.com

02

Espanha

Carretera de Moledo 8
pol. ind. de Miraflores, Nave 20
36214, Vigo (Pontevedra)

T:(0034) 986 378338
info@4x4misutonida.com
www.4x4misutonida.com

03

Austrália

19 Flinders Parade
North lakes
QLD 4509

T:(0061) 1300 236 494
sales@afn4x4.com.au
www.afn4x4.com.au

DON'T JUST SETTLE FOR THE SAME OLD BULL



WWW.AFN.PT | SALES@AFN.PT | FACEBOOK.COM/AFN4X4

WELCOME TO THE AFN FAMILY

